

Traillex

SPORT UTILITY TRAILERS

SUT-450-C

450 LB. CAPACITY

TRAILER

Assembly Instructions

SUT-450-C



ASSEMBLY REQUIREMENTS

- ✓ Torque all "T" bolt nuts to 38-40 foot pounds.
- ✓ Check all lights before towing
- ✓ Tire pressure not to exceed sidewall recommendation.
- ✓ Re-Torque wheel nuts after first 25 miles to 80 ft. pounds and periodically thereafter.

STEP 1

SUGGESTED TOOLS

Pliers

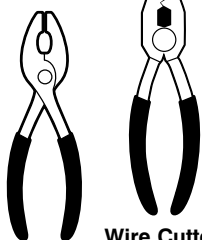

Wire Cutters

Square

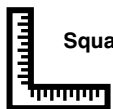

7/16" & 9/16" Open End

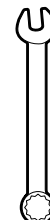

Torque Wrench

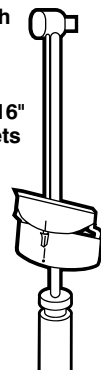

Ratchet & 13/16" & 9/16" Sockets

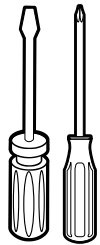

Std. & Phillips Screwdriver

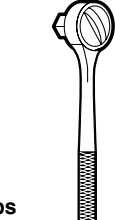

STEP 2

BOXES (SEE PHOTOS BELOW)

- ☐ Remove and Identify all parts from boxes. (Refer to exploded drawing parts list).
- ☐ Layout all parts to configuration of trailer using parts drawing as your guide.

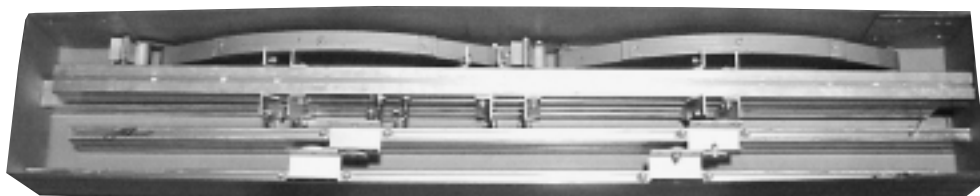

STEP 3

- ☐ Layout Frame (Box) Assembly (Shown in A). Slide side rails in "T" bolts (Shown in B)(2 in front, 2 in rear). Slide flush with side rail brackets (Shown in B). Square up all four corners and tighten bolts.

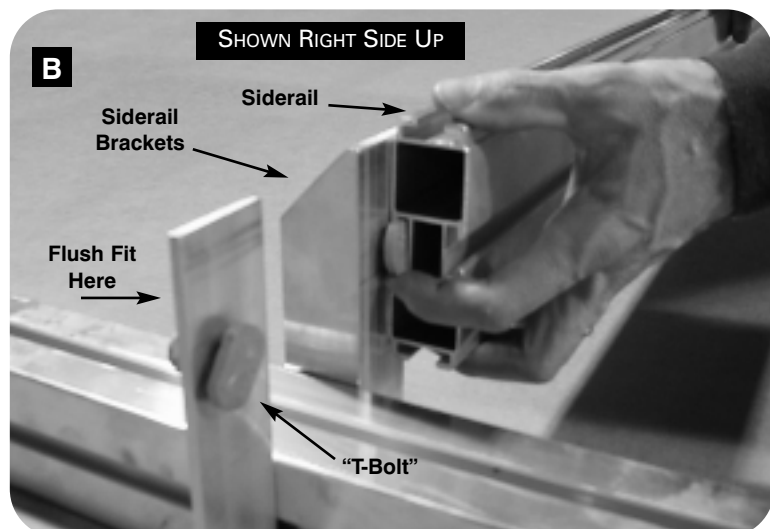
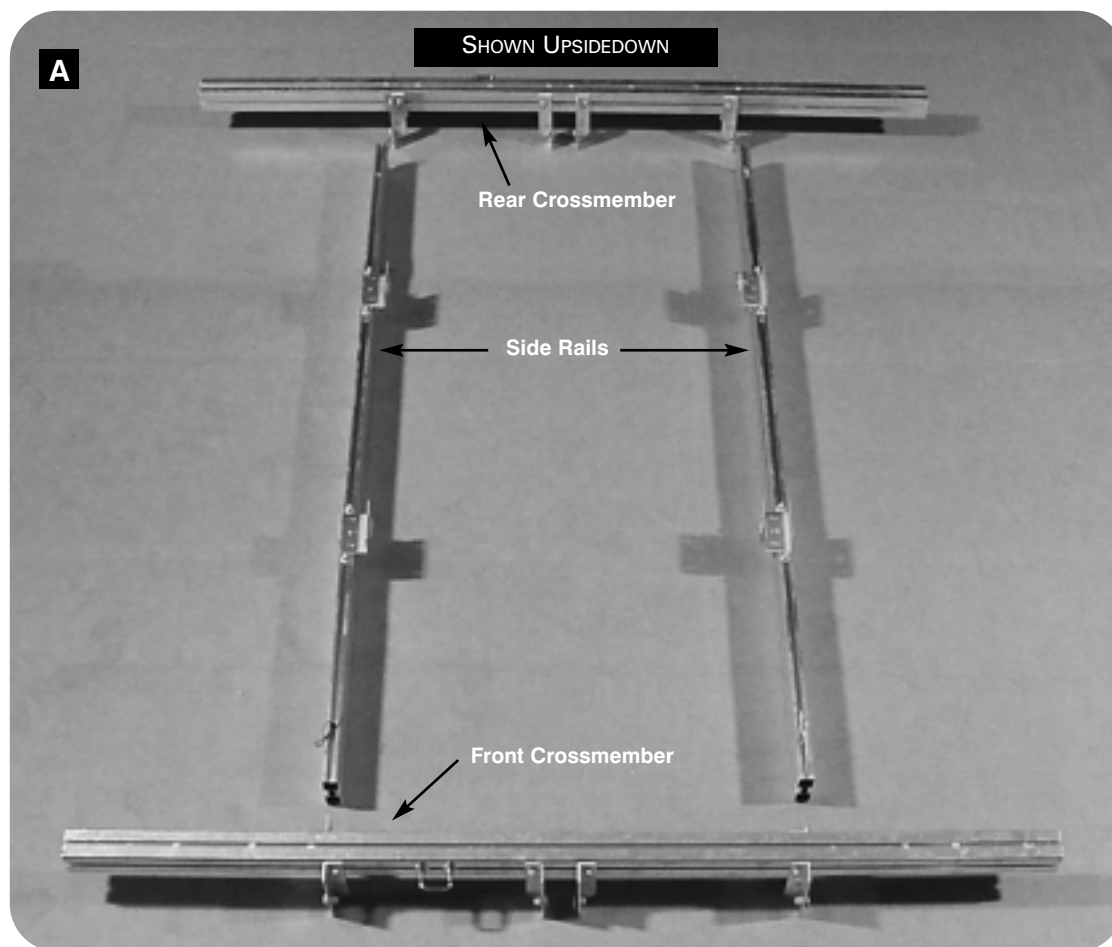

STEP 4

- ❑ Attach front of spring to center hole in subrail clip, (Shown in E). All bolts face inward with nuts on the inside of trailer. (Go to inset for detail). Attach shackle holder to rear subrail clip, using 2 outside holes. (Bolts contained in spring and shackle holder). Then tighten shackle bolts. Repeat other side.
- ❑ Lay axle on spring. Line up hole in axle plate with bolt in spring. Attach two U-Bolts, 1 Plate, 4 Lock Nuts - (Shown in C). Tighten U-Bolt nuts to 80 ft. pounds. Then go back and tighten spring bolts. Final assembly of axle to frame (Shown in D).
- ❑ Attach tires to hubs with lug nuts. (Torque bolts to 80 ft. pounds).
- ❑ TEST: With trailer right side up, assembled on ground put pressure on trailer frame and observe movement in spring shackle, spring and axle. If shackle stays firm, loosen counter clockwise 1/4" turn - until shackles move.

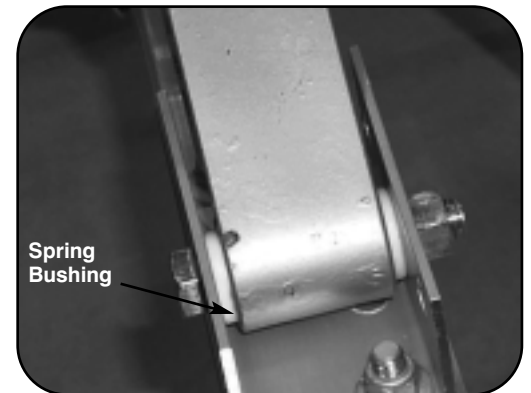
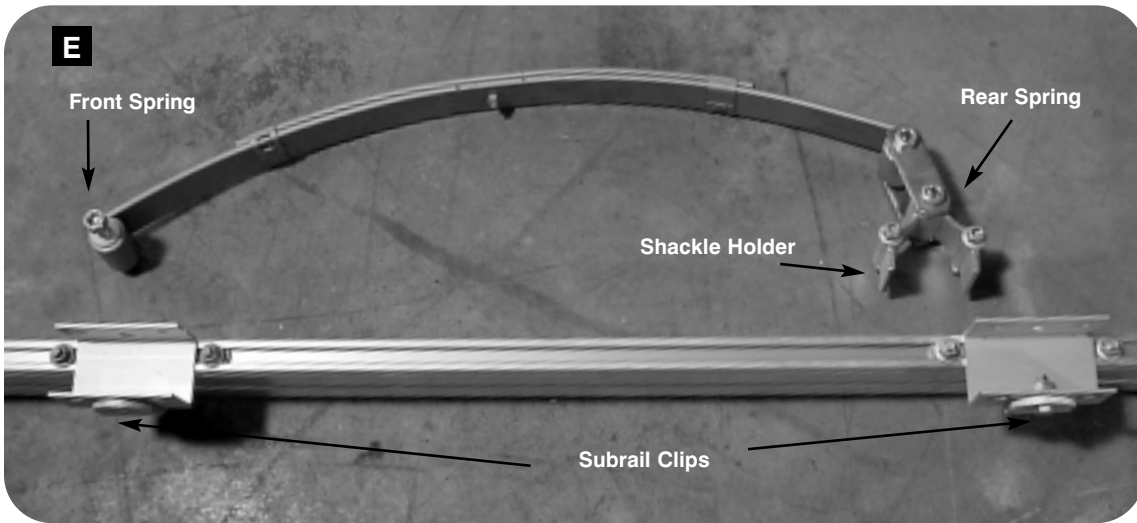
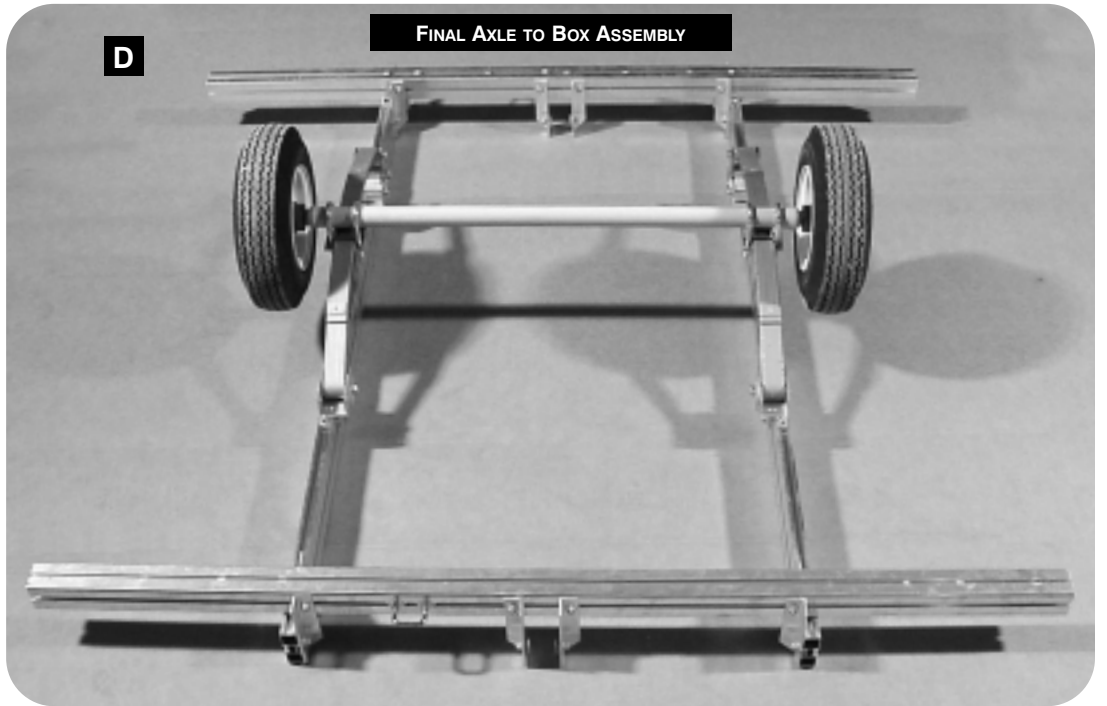
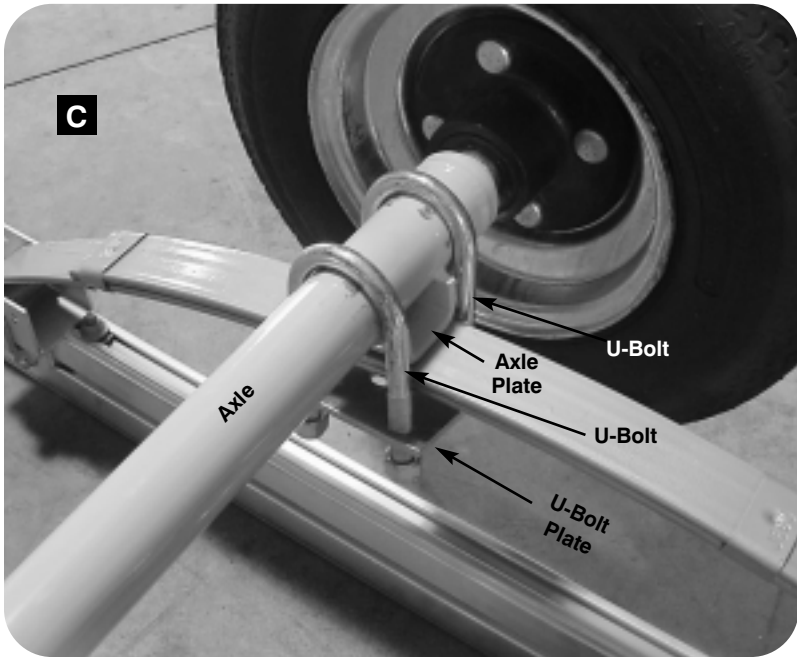

INSET
Picture shows bolts facing in and spring bushings in spring. Bolts tight, but not "pinching" spring motion

STEP 5

- ❑ Center fender over tire. Start with rubber washer, steel washer, fender, steel washer then lock nut(Shown in F).

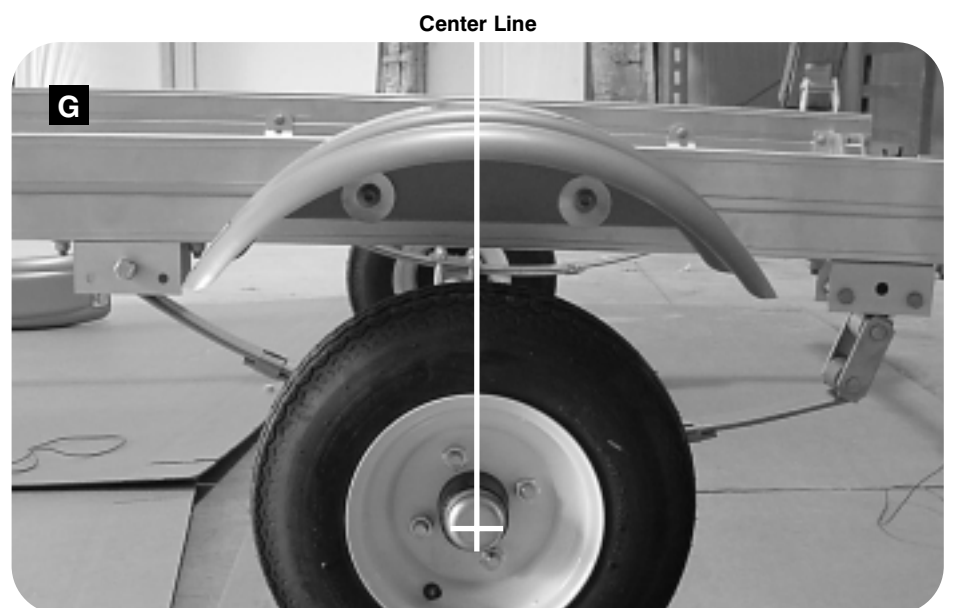
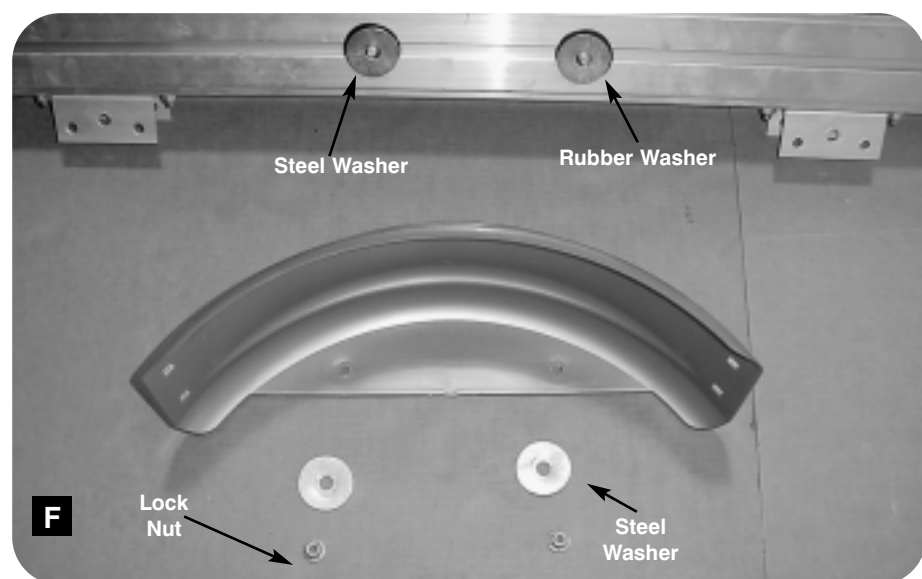

STEP 6

- ❑ With wiring harness halfway through tongue (Shown in I) push harness to the rear of the tongue. (Use tape measure, etc. to assist in pulling harness to rear of tongue)
- ❑ Put 4 "T" bolts in rear of tongue section. Slide 2 "T" bolts on each side splice plate (Shown in I). Tighten side plate bolts. Put bottom plate on 4 "T" bolts (Previously installed). Start nuts and slide bottom plate using side plates for alignment. **IMPORTANT:** Tighten all 12 nuts at this time.
- ❑ Finished tongue splice (Shown in J). Rear of tongue will be flush with rear of rear crossmember(Shown in K).
- ❑ Cut 10" off of ground wire (white wire). Strip 1/4" of insulation off of wire end. Install ring end by crimping onto bare wire. Using supplied screw, attach white wire to tongue using existing hole. (Shown in L).

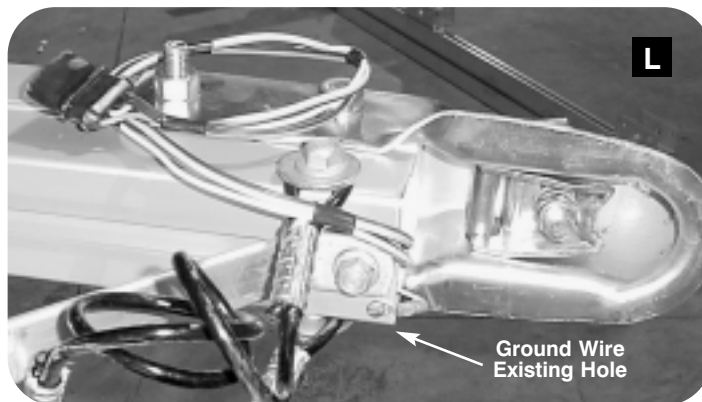
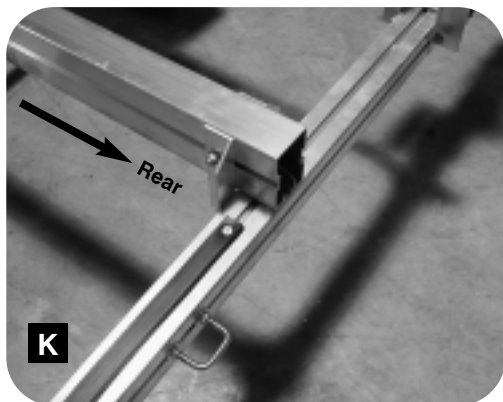
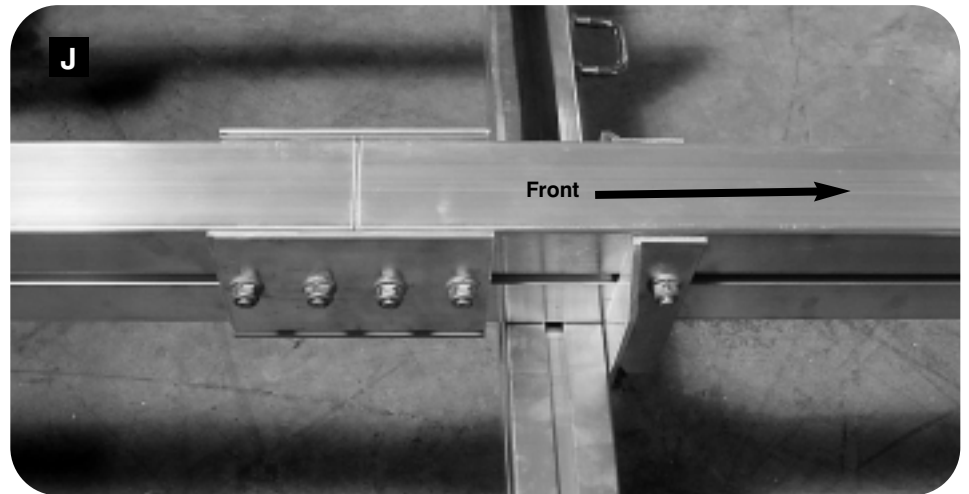
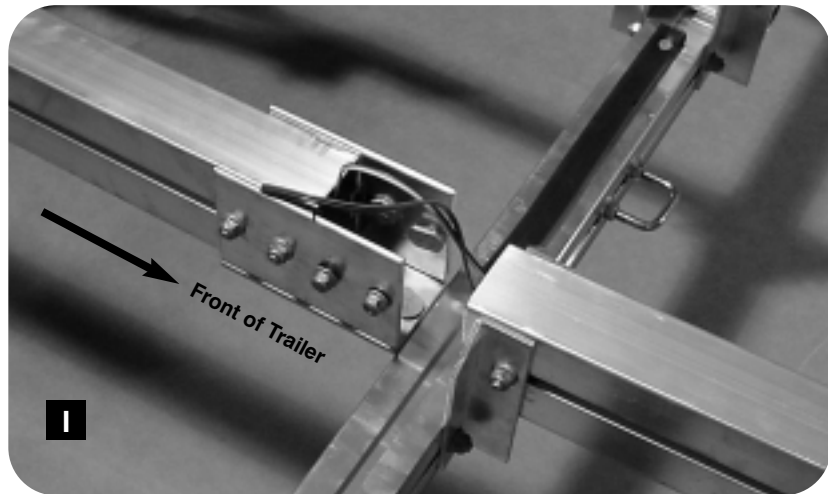
**STEP 7**

- ❑ **WIRING PATH:** Starting at rear of trailer. Feed harness back (towards front) through slot located on underside of tongue (Shown in M). Then along bottom edge of rear crossmember (Shown in N & M). Facing rear of trailer, split green/brown to passenger side taillight, and yellow/brown to driver side taillight. Pull harness 6" past tail lights, then cut harness (repeat opposite side).

TAILLIGHT INSTALLATION:

Install taillight brackets using T-Bolts and nuts provided. (Shown in O). Slide carriage bolts into grooves on taillights. Sandwich white ground wire between nut and tail light bracket. Do not over tighten nuts. Pull black tab on taillights and drop light bulb assembly out (this is how you will change bulb when needed). Strip 1/4" of insulation from wire ends. Attach the green/brown and yellow/brown wires to color matching wires in taillights. Separate green and yellow wires from brown wires of remaining harness (previously cut off). Discard green and yellow wires. Install one end of brown wire to brown terminal in taillights. Insert other end of brown wire into hole at rear of side rail. Push brown wire through side rail and out front hole. Strip 1/4" of insulation from brown wire and crimp on blue connector (Provided). Insert brown wire from marker light into other side of blue connector and crimp. Crimp ring end to white wire. Install marker light with ring end sandwiched between light and mounting bracket. Repeat other side.

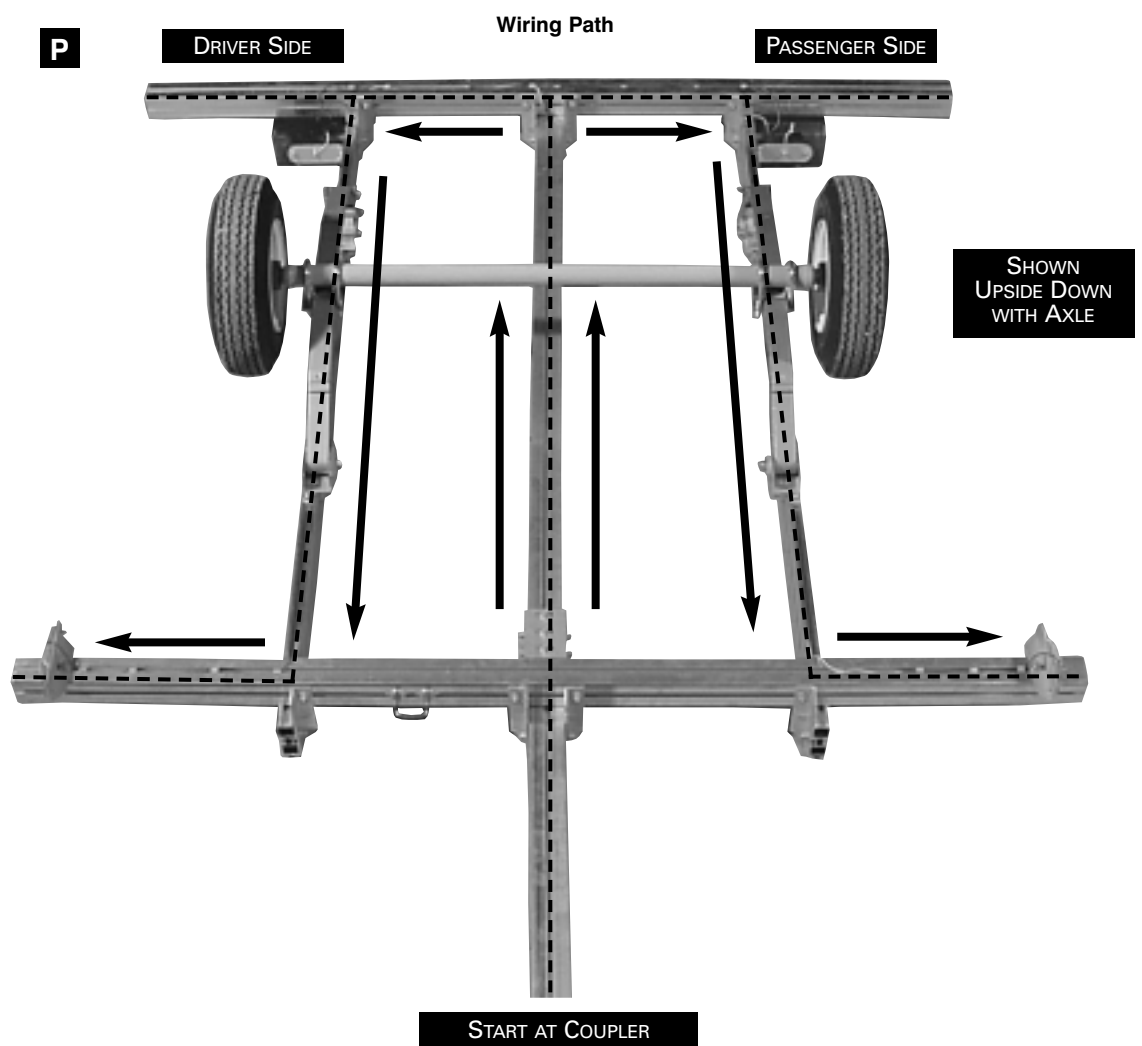

STEP 8

PADS - ROLLS - CLIPS: This is final assembly (Shown in Q) - Start with front crossmember. Slide rolls, with 2 bolts installed on first. Slide web strap clips on front side of front crossmember. Slide both alignment guides on rear crossmember using existing T-bolts (Alignment guides, installed with short side down). Slide rolls on top side of rear crossmember. Finally, slide web strap clips on back side of rear crossmember.

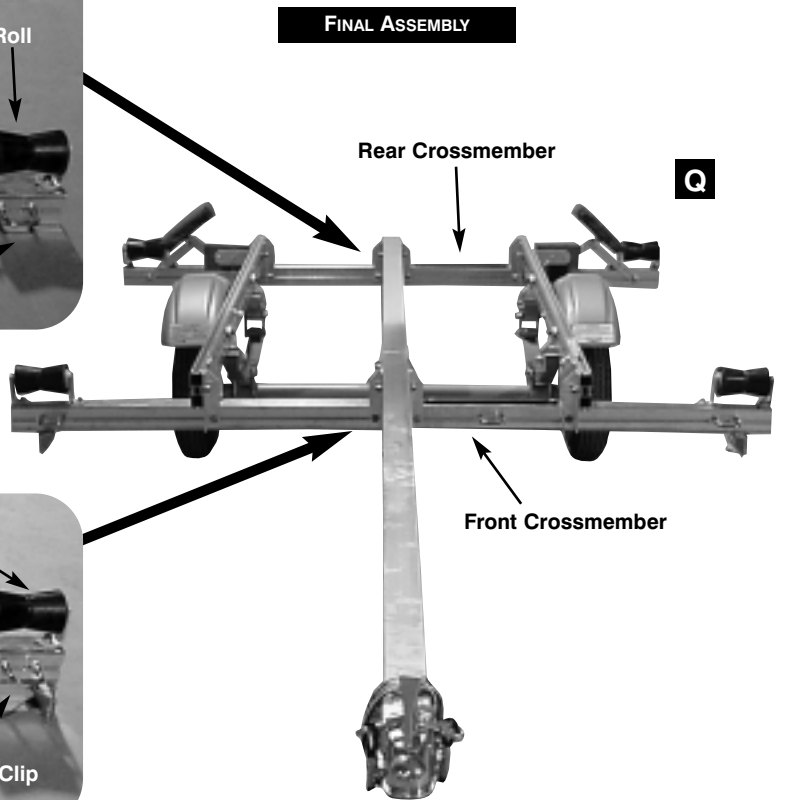
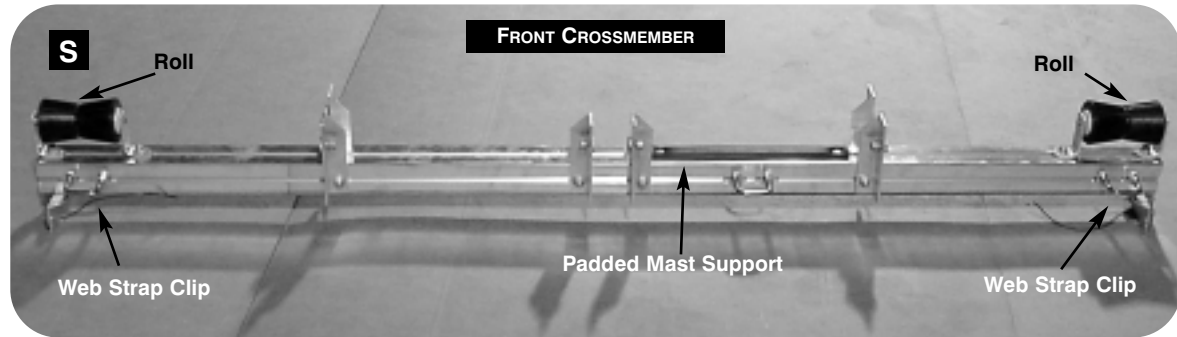
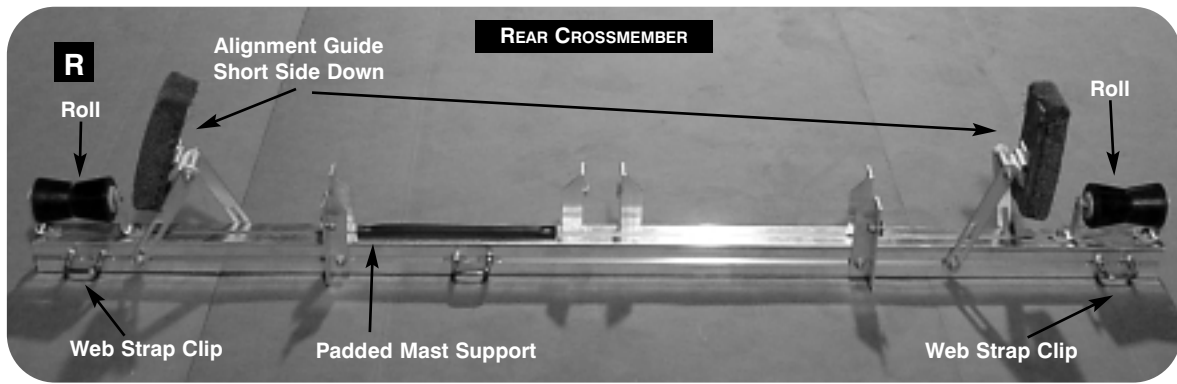

STEP 9

FINAL FIT: Make sure (2 carpeted rear) alignment guides touch inside of hull - boat rests on center of rolls. Use 2 front and 2 rear web strap clips for tie downs. Secure mast using padded mast supports and web strap clips.

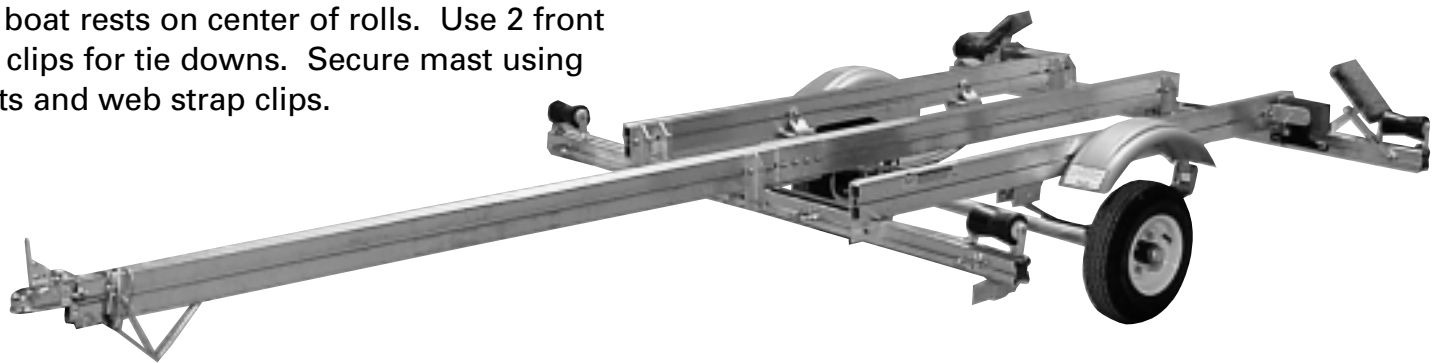

Other SUT Products Available - All Products are UPS-able

Trailer Dolly
SUT-HDKD



3-Bike Rack
SUT-BR-3



General Purpose Dolly
SUT-300GPD



Trolley Dolly
SUT-300TD



Single Boat
SUT-200-S

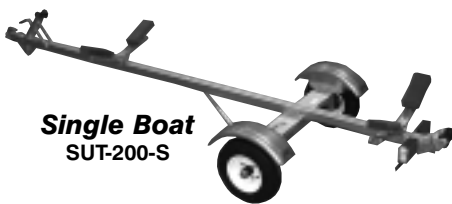

Inflatable
SUT-450-I



Catamaran
SUT-450-C

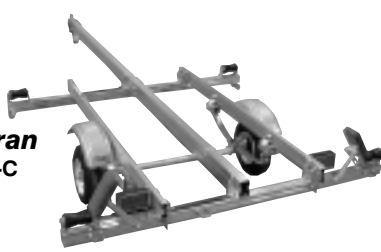

250lb. & 500lb. Capacity Multi-Carriers
SUT-250-M & 500-M



Laser I & II
SUT-250L & LII



250lb. & 500lb. Capacity Trailers
SUT-250-S & 500-S



TRAILLEX SUT PRODUCT LINE PRODUCT WARRANTY

Traillex Incorporated, 1 Industrial Park Drive, Canfield, OH 44406, states that this Warranty is designed and intended to fully comply with the requirements of Magnuson-Moss Warranty Act and all the Regulations issued by the Federal Trade Commission in connection therewith. It is not intended to violate any applicable State Law or Regulations containing more stringent requirements.

I. Duration
This warranty is given and extends for a period of one year (three hundred and sixty-five days) from date of original purchase. The implied Warranty of merchantability and fitness for particular purpose are limited to the duration of this Warranty - one year (three hundred and sixty-five days). After said one year (three hundred and sixty-five days), Traillex Incorporated expressly disclaims any Warranty of merchantability or fitness for any purpose.

II (A) Coverage
Traillex Incorporated warrants its products to be free of defects in material and workmanship under normal use and with reasonable care and maintenance, and under such conditions as set forth in this Warranty. Traillex Incorporated's obligation shall be limited to repairing or replacing defective parts at its factory at 1 Industrial Park Drive, Canfield, OH 44406, telephone number (330)533-6814, or at any authorized dealers. Any part or parts covered by this limited Warranty shall, within the one year (three hundred and sixty-five days) period hereinafore specified, be returned to it with transportation prepaid and which, upon examination by Traillex Incorporated or an authorized dealer, show to have been defective. This Warranty extends to the original purchaser only and those protected by existing law and is not transferable.

III. Exclusions
This Warranty specifically does not cover:
(a) Expendable items including tires, cables, ropes, lines, brakes, tie downs, etc.
(b) Cost of repairs made other than by Traillex Incorporated or an authorized dealer.
(c) Products which shall have been repaired or altered by other than Traillex Incorporated or an authorized dealer.
(d) Products which shall have been subject to negligence or accidents or damage by circumstances beyond the company's control, or by improper operation, over-loading beyond stated capacity, maintenance or storage, or were used other than the normal use of service for which the trailer is intended.
(e) With respect to any component of the products covered by this Warranty which shall not be actually manufactured by Traillex Incorporated, the Warranty extended to the purchaser or claimant shall be limited to the Warranty extended by the manufacturer.
(f) Traillex Incorporated does not undertake responsibility to any purchaser of its products for any undertaking, representation or Warranty made by the dealers or third persons selling its product, beyond the Warranties herein expressed.
(g) Purchase of other acceptance of the products by any claimant under the Warranty provisions shall be on the condition and agreement that Traillex Incorporated shall, under no circumstances, be liable for any direct, indirect, consequential, contingent or incidental damage of any kind or nature whatsoever, including, but not limited to damage to any personal property or real property of the purchaser or others resulting from any breach of this limited one year (three hundred and sixty-five days) Warranty.

(h) Warranty voided if load equalizer type hitch is used.
(i) Warranty void if assembly instruction requirements are not precisely followed

IV. Claim Procedures
To make claim under this Warranty, write or call directly to Traillex Incorporated, 60 Industrial Park Drive, Canfield, OH 44406, Telephone Number (330)533-6814, identifying the trailer by serial number and giving its location. The company will give instructions within the (10) days following receipt of said claim. Traillex Incorporated will exert its best effort to repair or replace the part or parts if found to be defective within the terms of this Warranty, within (60) days after notification of the claim. In addition to the provisions of this Warranty, the retail purchaser has available the legal remedies provided by the Magnuson-Moss Warranty Act, Public Law 93-627, 88 Stat. 2183-2193, U.S. Code, Secs. 2301-2312, and any applicable State statutes.
(j) Void if weight limit of vin tag is exceeded.

Warranty



P.O. Box 553 • 1 Industrial Park Dr.
Canfield, OH 44406-0553
Phone: (330) 533-6814
Fax: (330) 533-9118



SUT-450-C for Catamarans
Additional Trailers and information can be seen from
our web site at: www.trailex.com

Made In U.S.A.