

SUT-450-M6

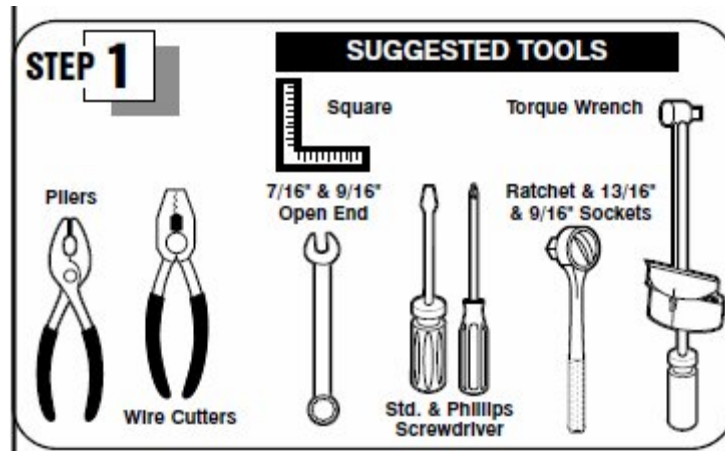

ASSEMBLY REQUIREMENTS

***Torque all T-bolt nuts to 35-40 foot pounds.**

***Check all lights before towing.**

***Tire pressure not to exceed recommendation on serial tag.**

***Re-torque wheel nuts after first 25 miles to 80 ft pounds and periodically thereafter.**

Failure to follow the assembly instructions could result in serious injury or death.

Incorrect assembly or modifications to your trailer will void any specific or implied warranty.

For questions or assistance assembling your trailer call 800-282-5042.

UNPACK AND IDENTIFY THE FOLLOWING PARTS.



Tongue sections, splice plates, and coupler.

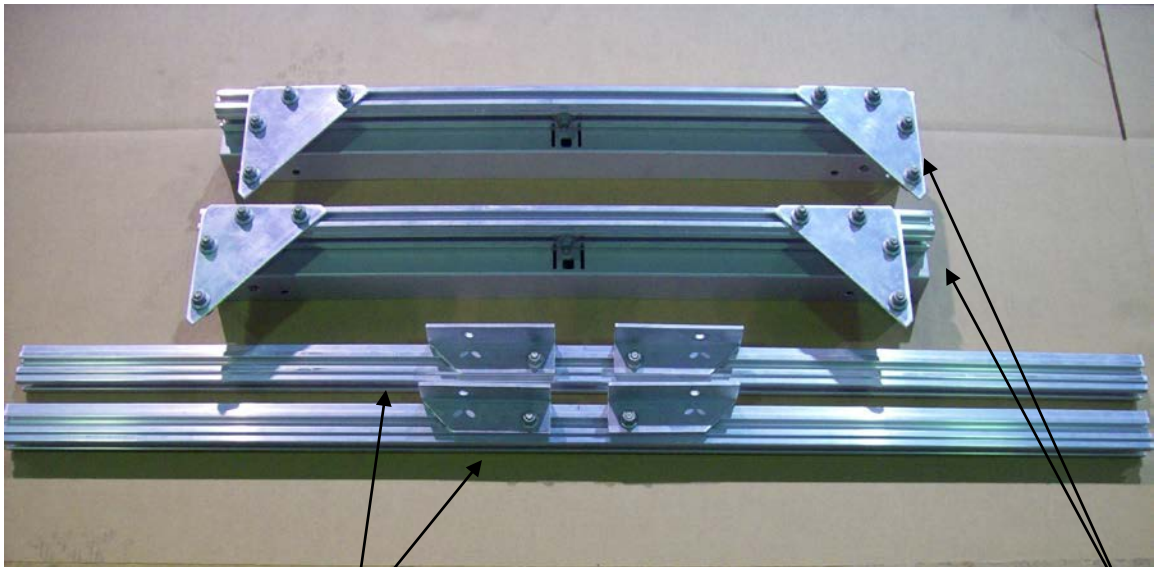

Cross members

Side rails



Axle assembly, springs and U-bolt hardware.



Light kit, harness, tail light brackets, skid, side marker light bracket, web strap clips, and vertical support brackets.

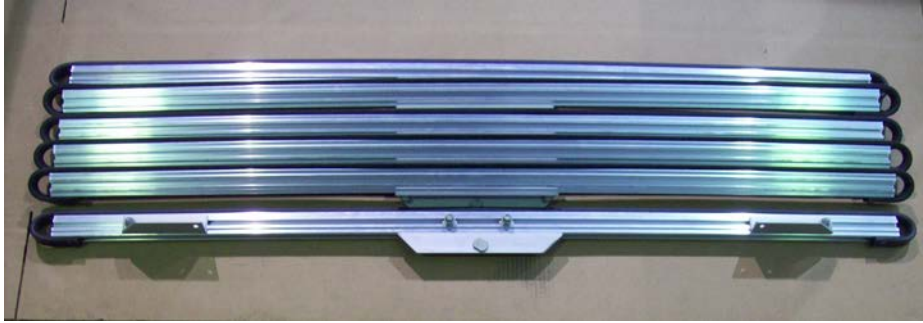

Rear lower cross bar with angle supports

Six crossbars

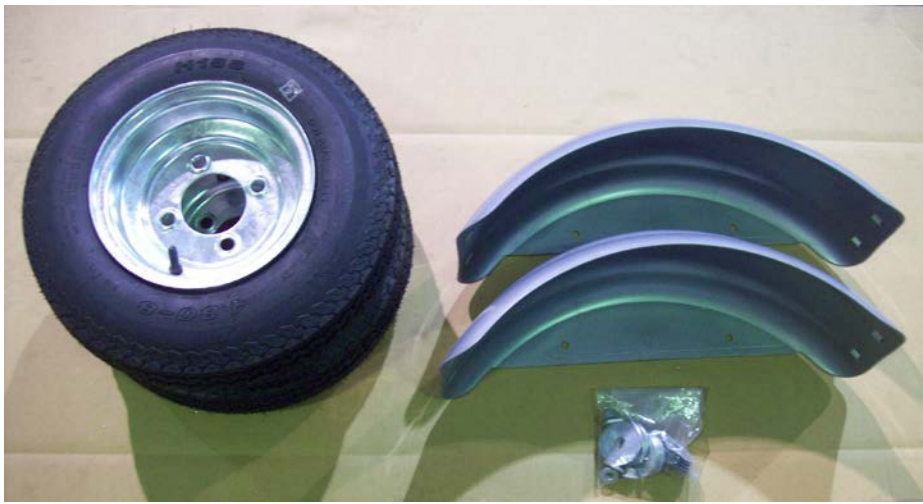

Tires, fenders, and hardware.



Horizontal support, angle supports and vertical post for cross bars.



Safety hitch cables and hardware.

Optional step for spare tire carrier

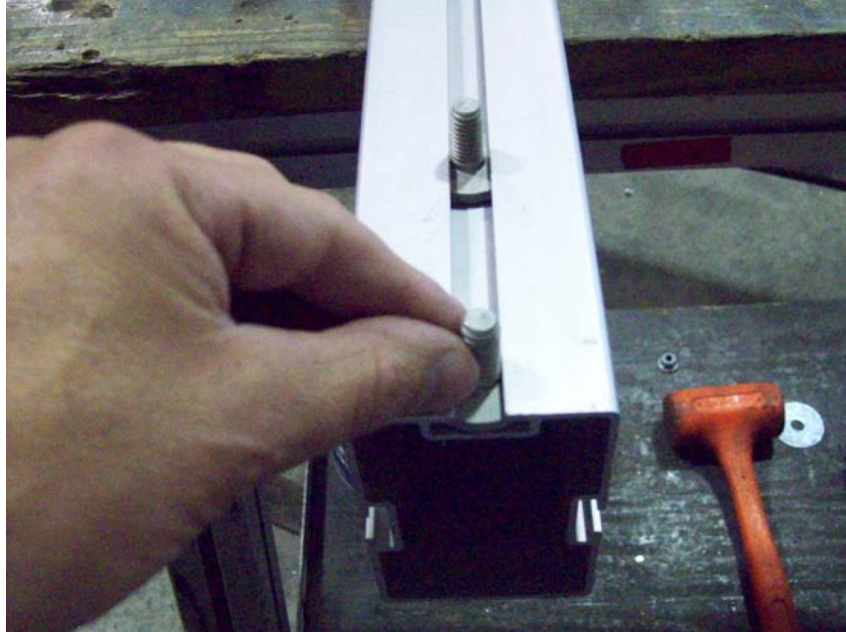

Slide 2 T-bolts on the underside of the front tongue section that has the serial number on it.

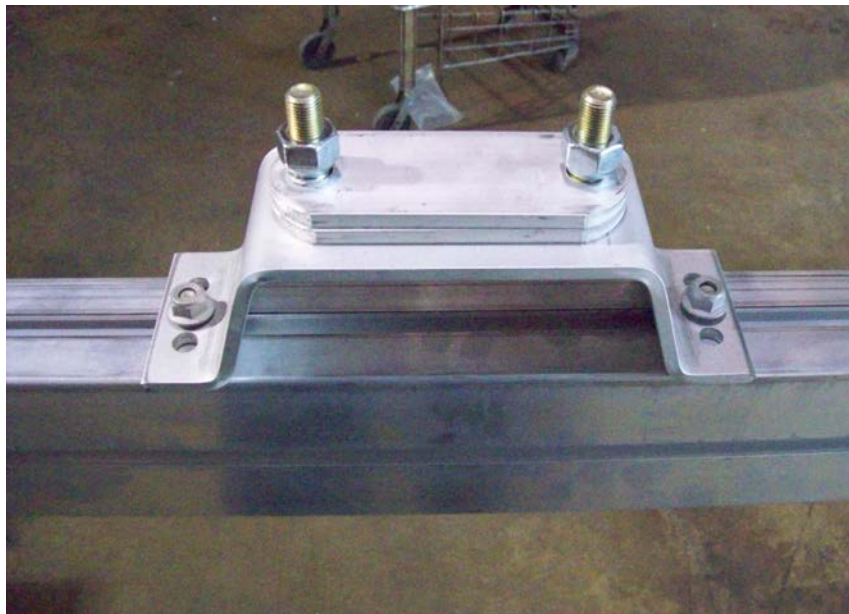

Position carrier about 12" away from the splice plates and tighten nuts.

Tongue assembly



Before putting the tongue section together add three T-bolts to each side of the front tongue section. These will be used later for the front post and angle support.



Locate the splice plates, 12 T-bolts and nuts.



Install T-bolts on to splice plates then slide them on the tongue section as shown.

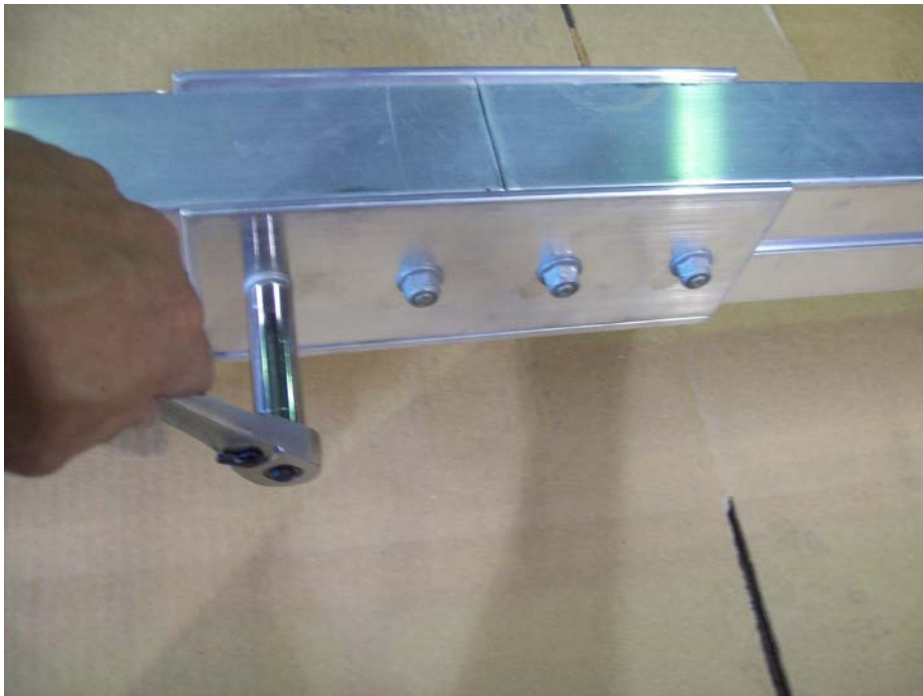

Slide 2 side plates over the adjacent tongue section until the plates are centered between the tongue sections. Tighten nuts.

Installation of coupler



Install coupler on tongue section with vin # on it, holes are pre-drilled in the tongue.



Install a 3 1/4" bolt through the rear hole of the coupler.

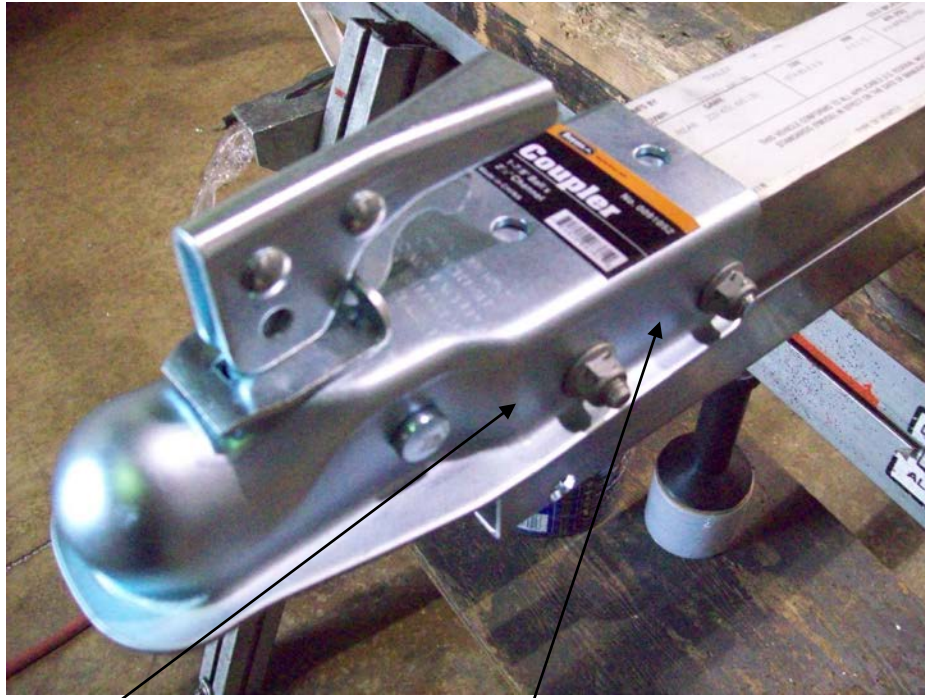

Repair T-bolt

3 1/4" bolt

Install the repair T-bolt on the inside of the tongue to go through the front hole in the coupler. Then install nuts and make sure to tighten.



Safety hitch cables and hardware



Install the repair T-bolt on the inside of the lower tongue section. Next add the cable over the bolt then a flat washer and the nut.

Frame Assembly

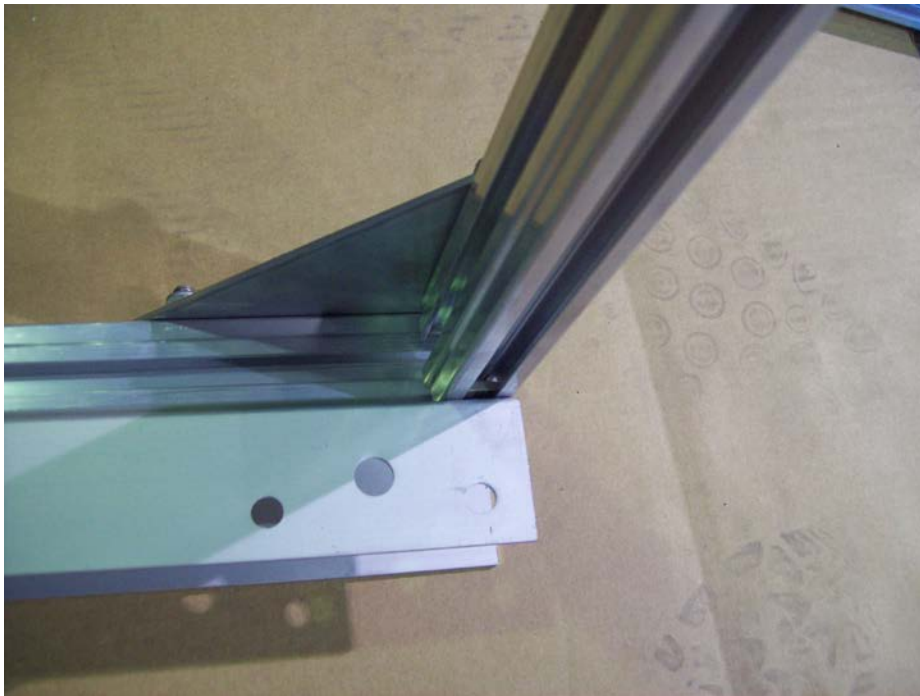

Insert the cross member into the T-bolts on the front of the side rail.



Once in place, square the frame and tighten nuts on corner brackets.



Install cross member into rear of side rail as shown. Then square frame and tighten nuts on corner brackets. Repeat this process for the other side rail.



Once frame is squared up and nuts have been tightened, turn frame over. Then tighten nuts on the underside of the rail front and back as shown.

Frame Attachment

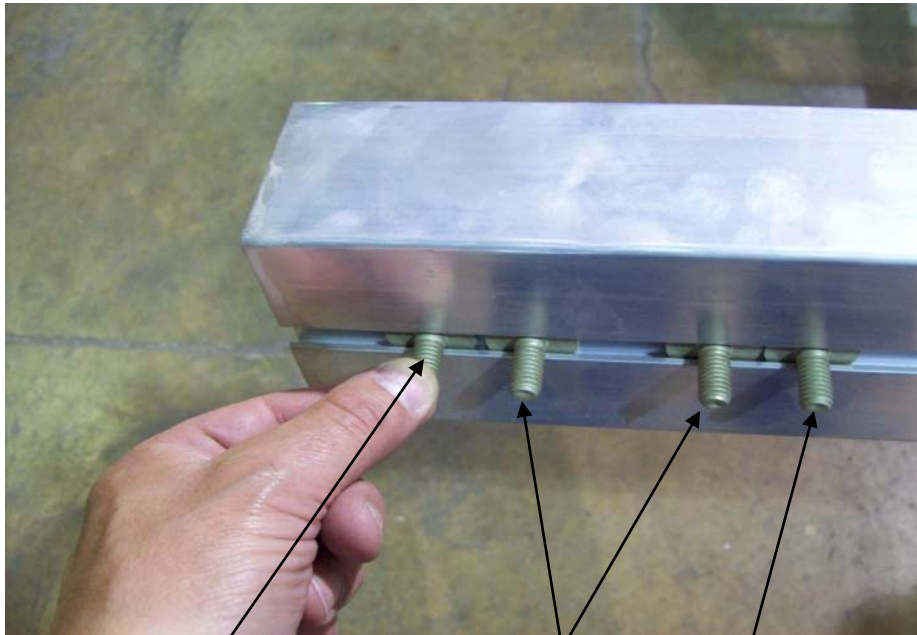

Frame bolts

Vertical supports

Frame bolts

Install four T-bolts into each side of the rear tongue section. These will be used to attach the frame and vertical support.

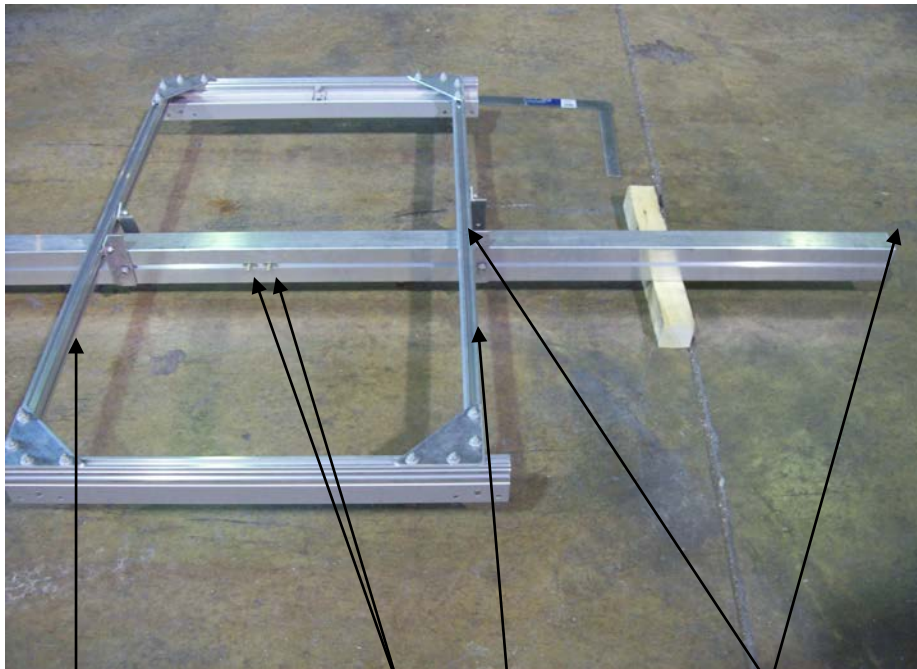

Front cross member

Vertical support T-bolts

Rear cross member

37 inches

Lay the finished frame on the tongue section as shown. Position the rear cross member 37 inches from the rear of the tongue. Make sure to have two T-bolts centered between the cross members on each side, these will be used later.



Pencil marks

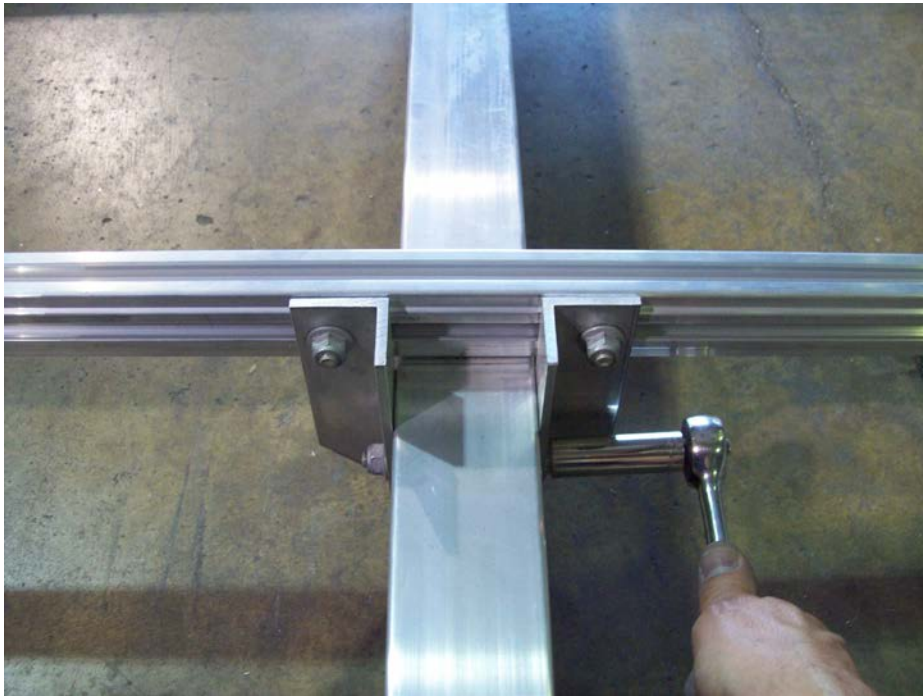

Loosen angle brackets to attach the frame to the tongue section. Slide angle brackets on cross member over to tongue section and align with T-bolts on tongue. Make sure tongue is centered on pencil marks that are on the cross members. Tighten all nuts.

Spring Installation

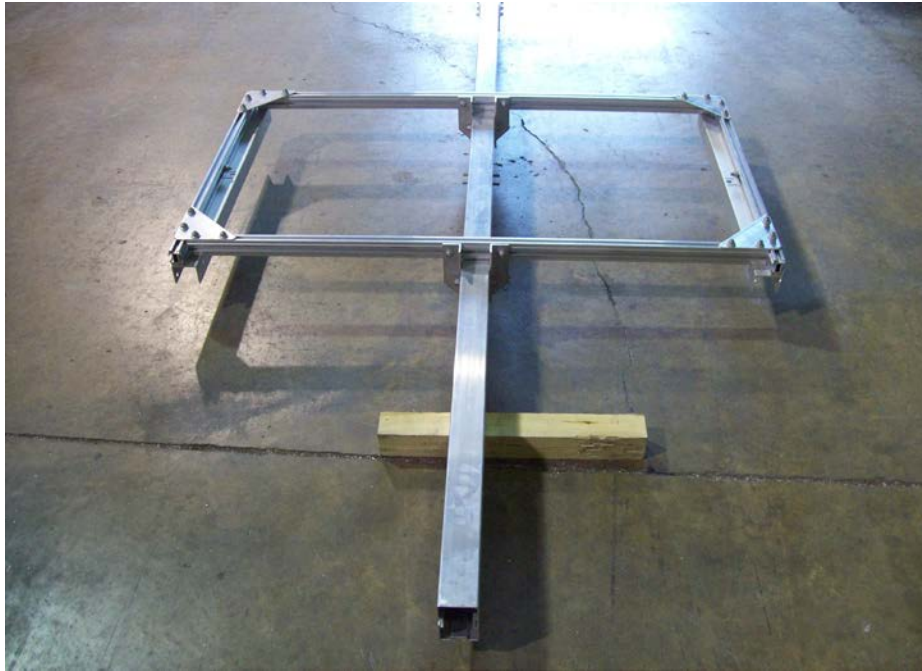

Your trailer should look like this at this point. Now turn frame upside down to mount spring assemblies.

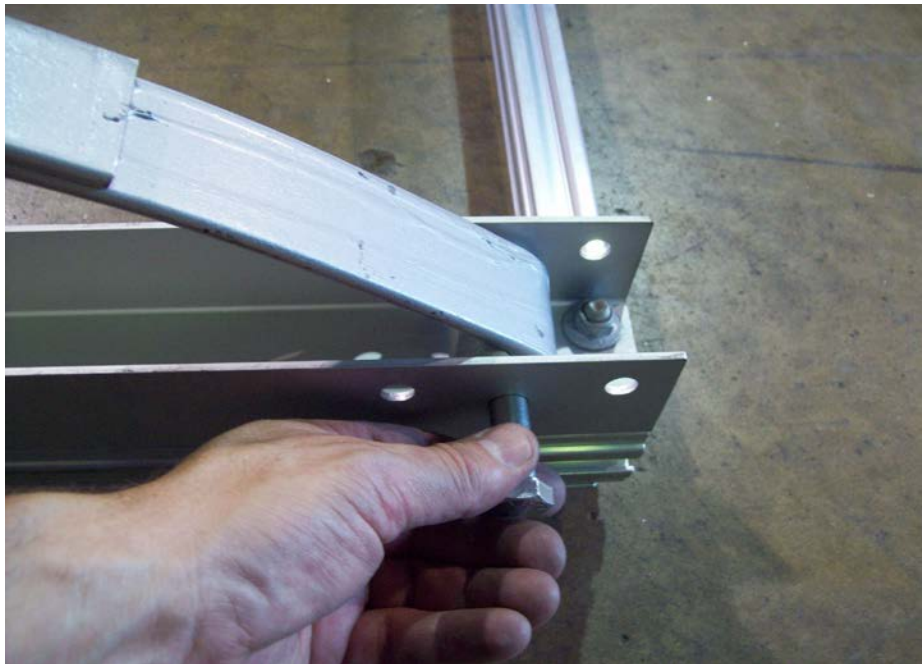

Remove the bolt from the front spring eye and install the spring into the spring hanger in the center hole with the nut toward the inside of the trailer. Do not tighten yet.

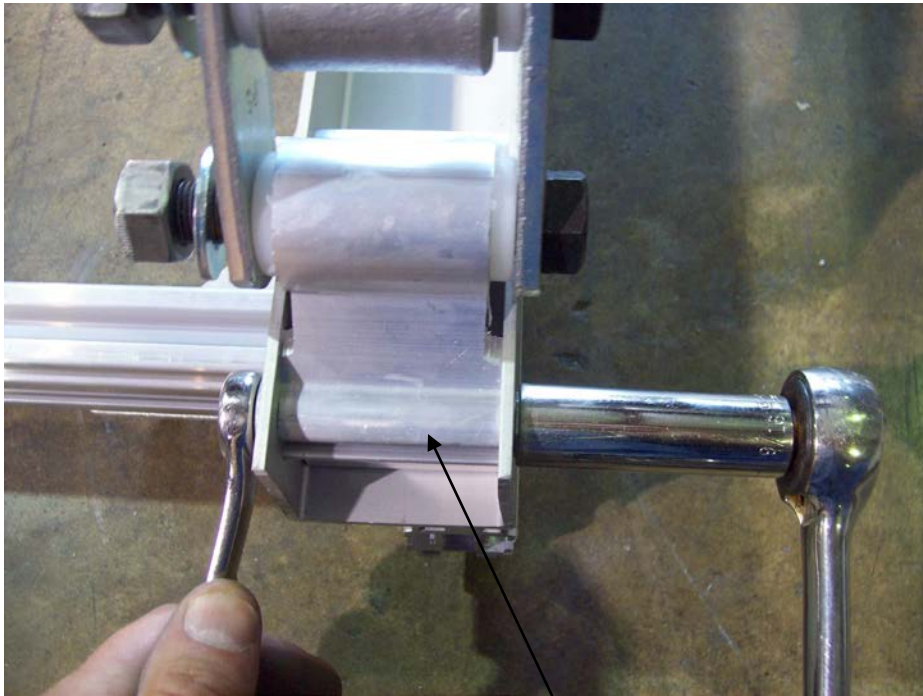
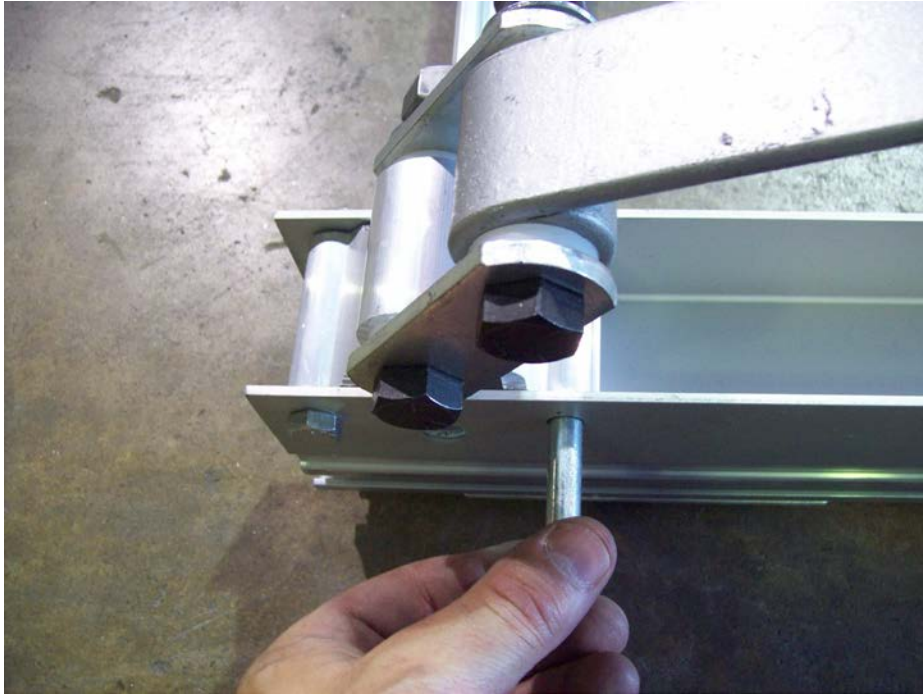

Shackle holder

Remove the two bolts from the shackle holder at the rear of the spring and install the shackle holder into the rear spring hanger with the nuts toward the inside of the trailer. These nuts can be tightened at this time.

Axle Installation

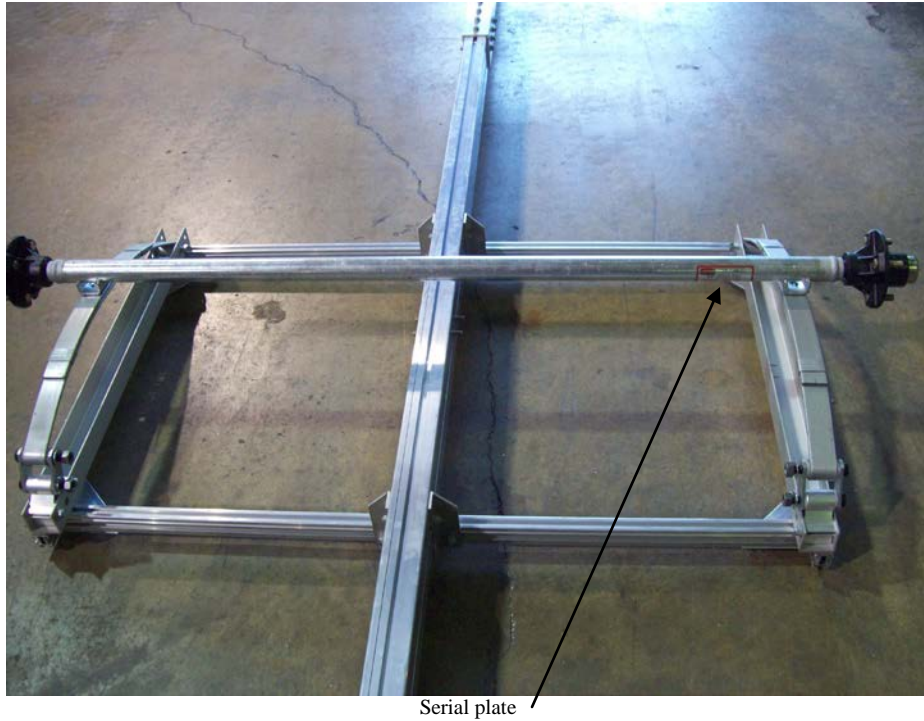

Locate the axle and install it on the springs as shown. Make sure the locating studs on the springs are in the holes on the axle's spring seat. Face the axle's serial plate toward the rear of the trailer to protect it from debris.



Locate the U-bolts and tie plates.



Install the U-bolts and tie plates as shown.

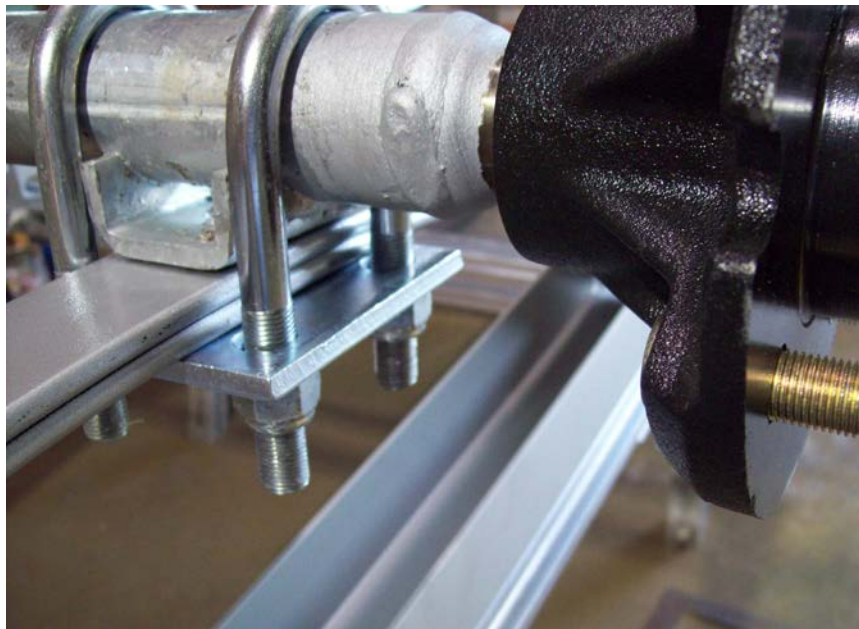

Install the nuts and tighten them evenly.

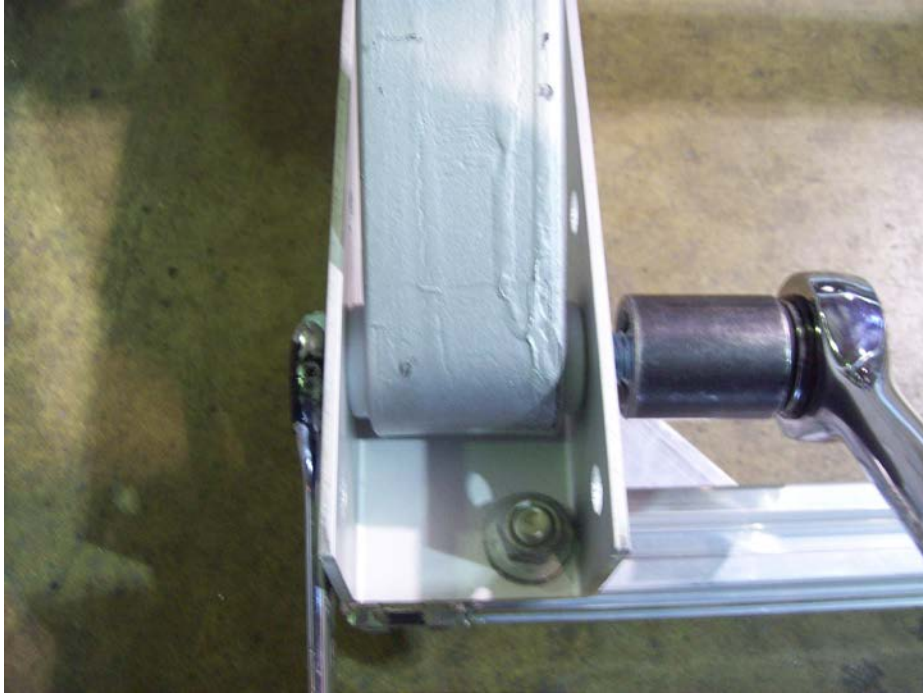

Go back and tighten all of the spring mounting nuts that were left loose previously.

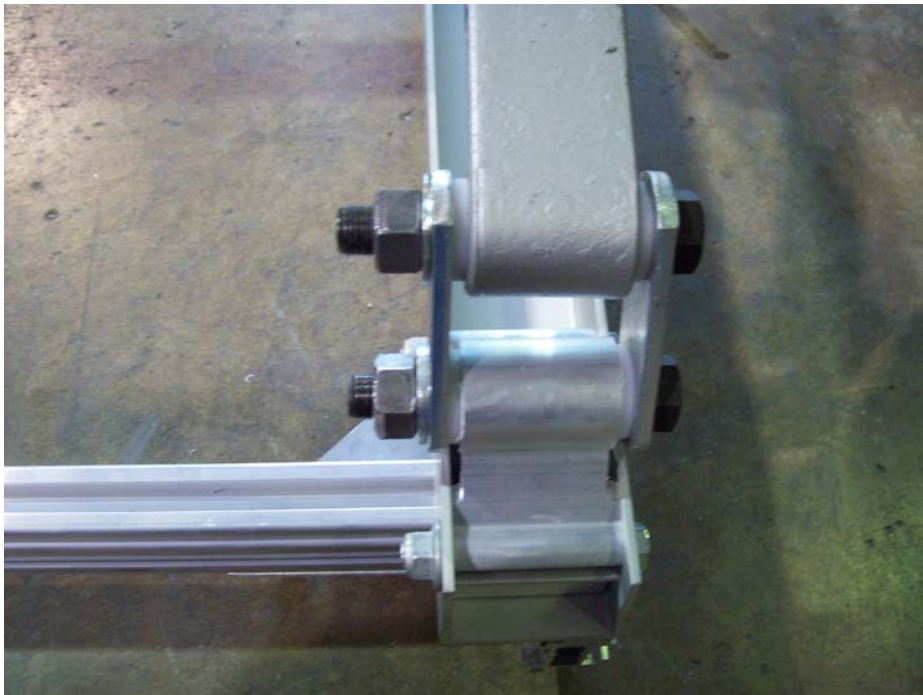

On the rear shackle, do not over tighten as this will not allow the suspension to move properly.

Wiring



Locate harness and ring terminal.

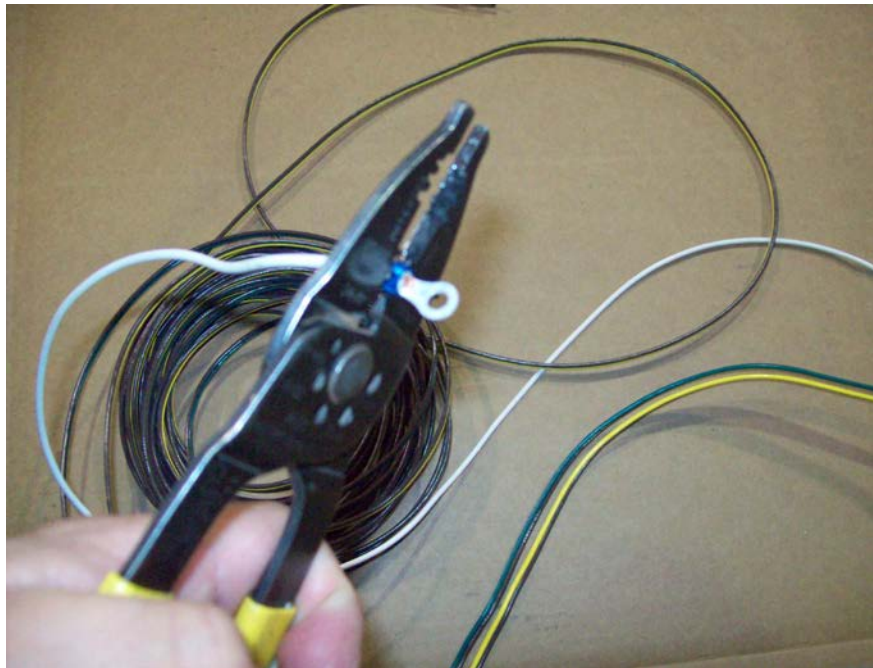

Take the white ground wire and strip it and install ring terminal.



Locate the 3/4" long Philips screw.



Install Philips screw through the ground wire into the pre-drilled hole located under the tongue just behind the coupler.



Extend a tape measure inside the tongue from the rear of the trailer until it protrudes at the front of the trailer under the coupler.

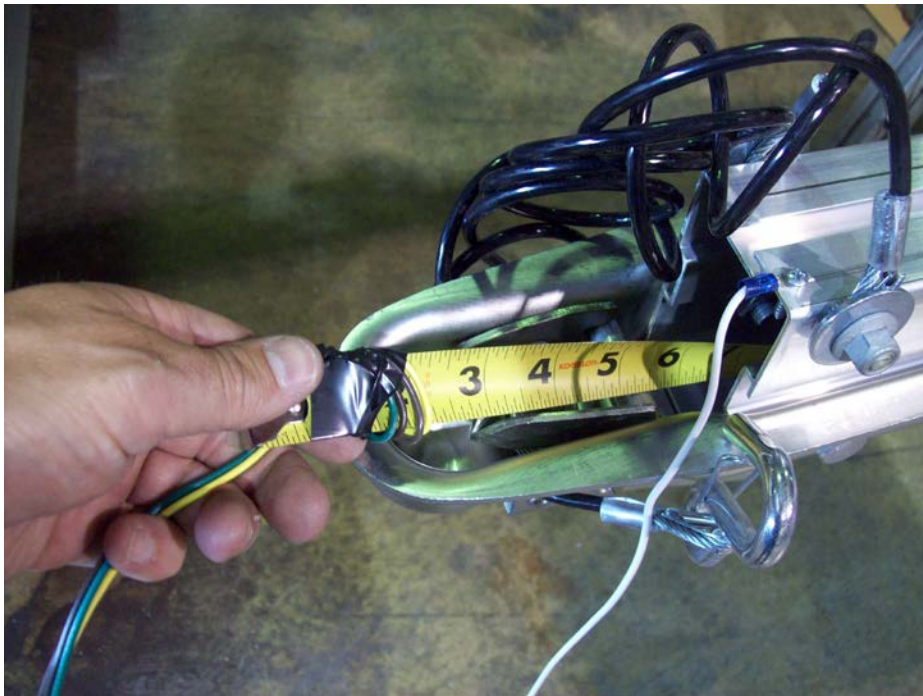

Attach both wires of the harness to the end of the tape measure with either tape or a tie.



Retract the tape measure until it comes out the back of the tongue with both wires attached.

Tail light brackets, tail lights



Locate the tail light brackets.

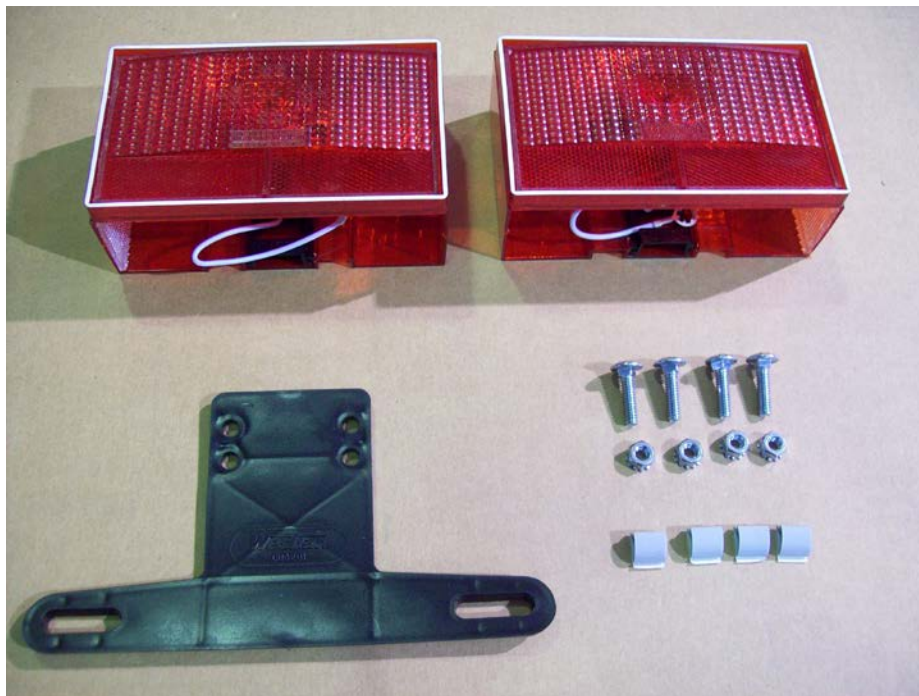

Locate the tail lights, carriage bolts, nuts and license plate bracket.

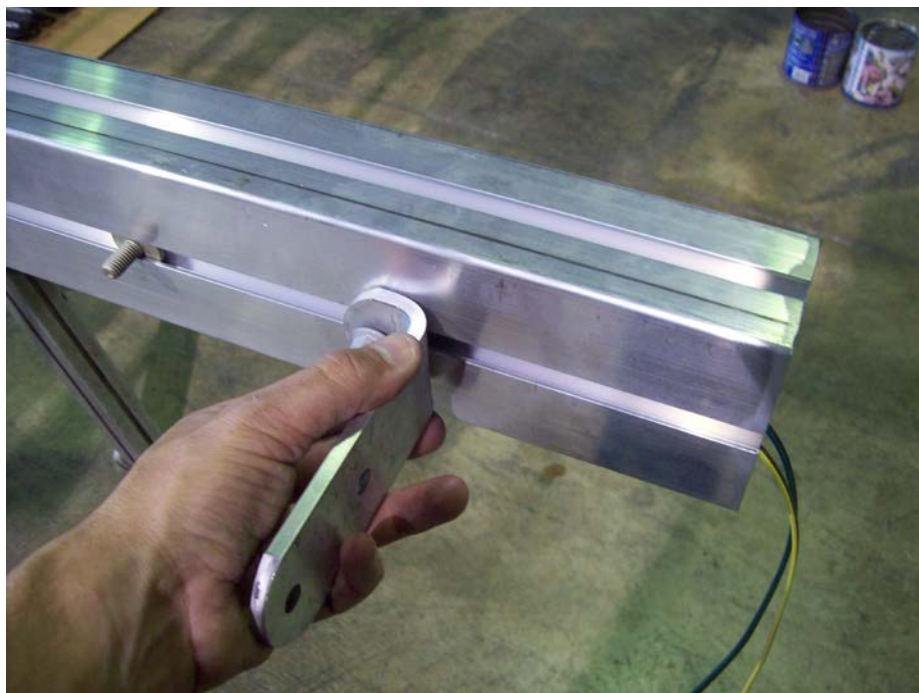

Install the tail light brackets on the rear of the tongue as shown.



Position the tail light brackets 4" from the rear of the tongue.

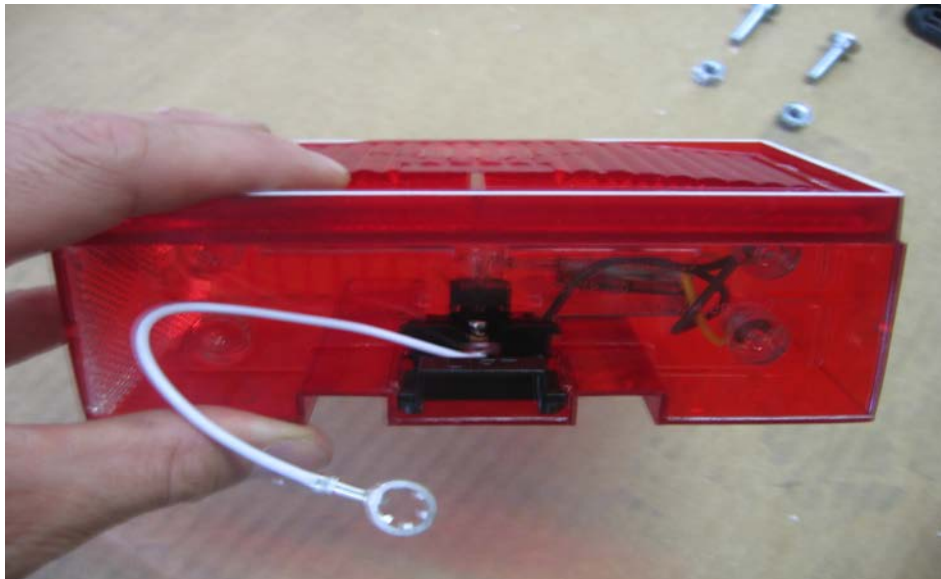

The light with the yellow wires is for the left (driver's side) of the trailer.

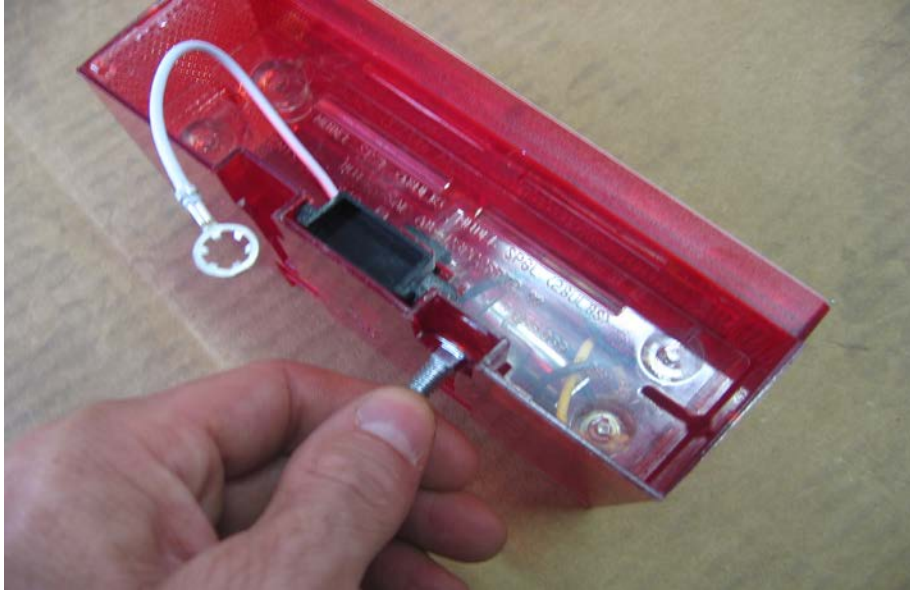

Slide the carriage bolts into the slots in the back of the tail lights.



Install the left tail light with the license plate holder between the light and the bracket. Repeat for the other side. Make sure to tighten nuts but don't over tighten them. (Pictured from the bottom)

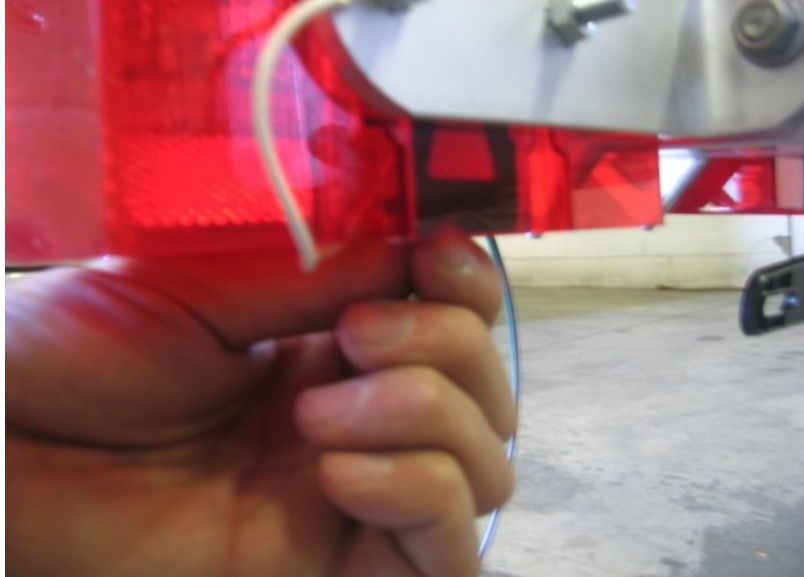

Locate the black tab at the bottom of the tail light. Move the tab toward the rear of the trailer and pull down releasing the bulb assembly from the light housing.

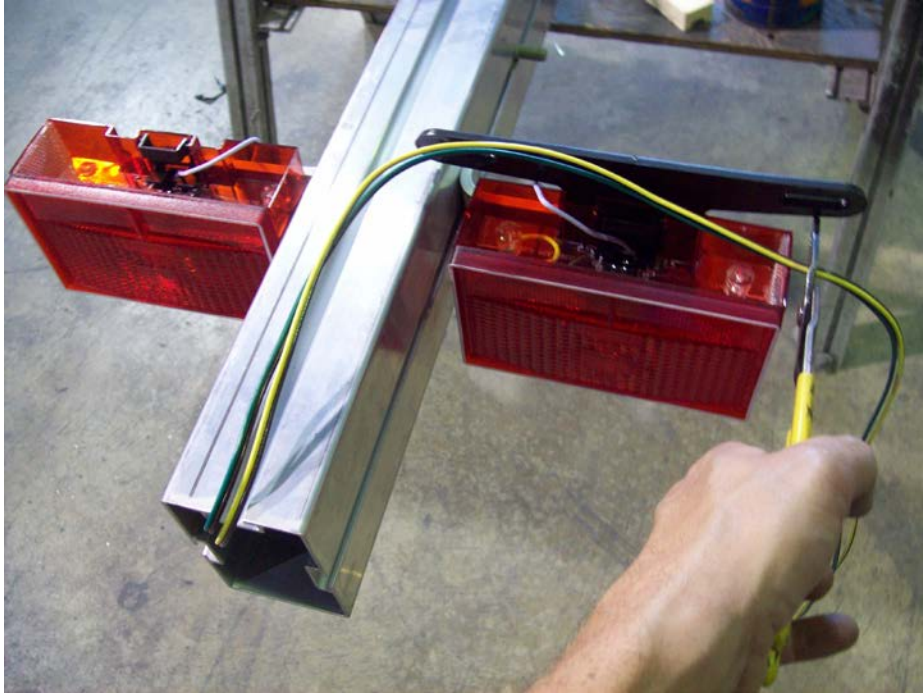

Trim off excess wire leaving some for adjustment.

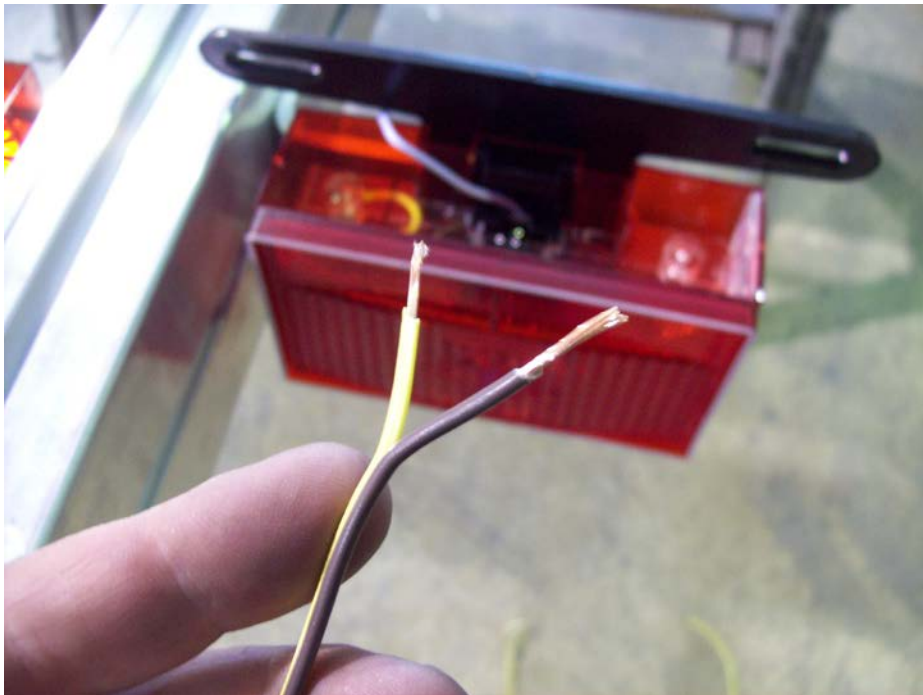

Strip about a 1/2" of casing from the harness.

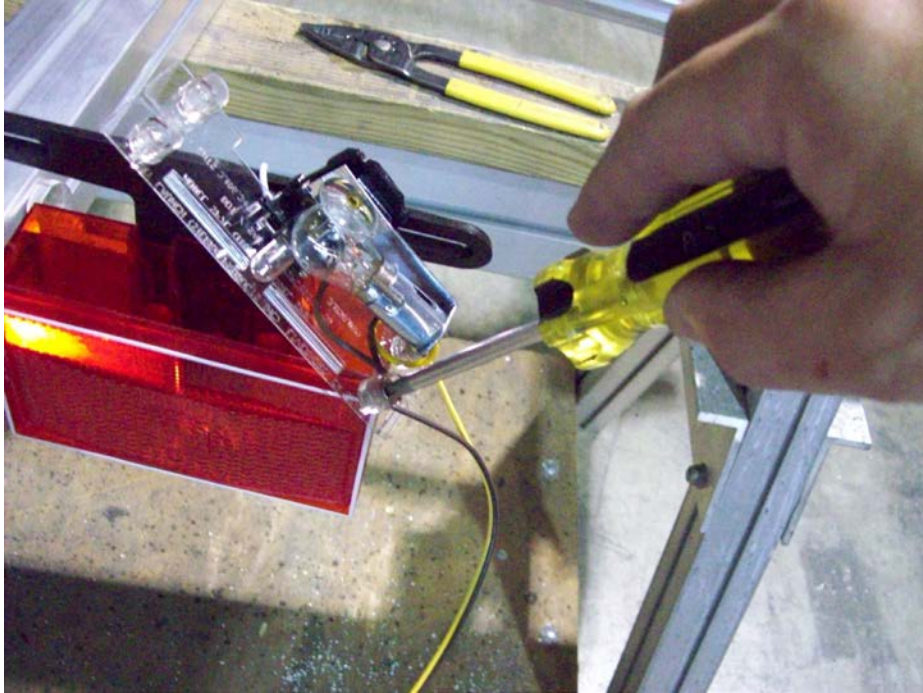

Loosen the wire retaining screws and install the color matching wires from the wire harness onto the corresponding retaining screws.

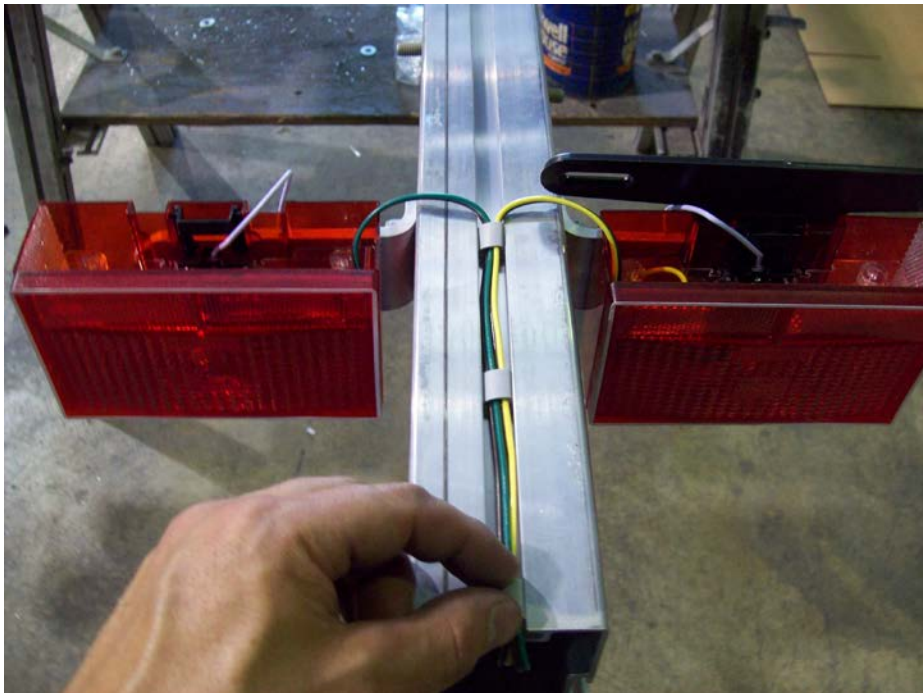

Re-install the bulb assembly into the light housing making sure to route the wires through the slot in the base of the bulb assembly. Install adhesive backed clamps in the locations shown and route the wires through them.

Running lights bracket and skid.

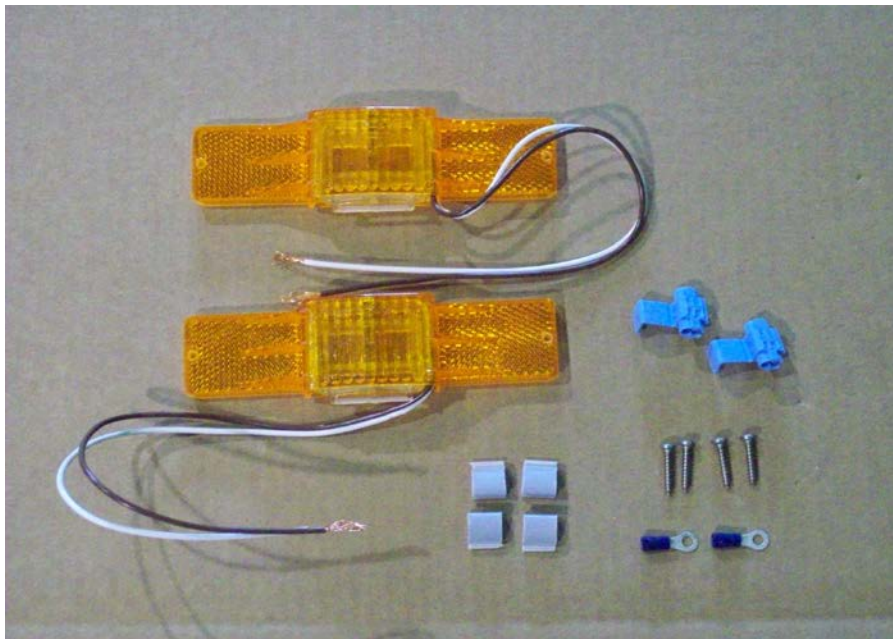

Locate the two amber running lights, four small Philips screws, adhesive backed clamps, two ring terminals, and two blue connectors.



Cut approximately 8 ½" off of the white wires on both running lights.



Strip 1/4" of insulation from the wire.



Install the ring terminals by crimping the terminal onto the bare wire.



Locate the skid and light bracket.

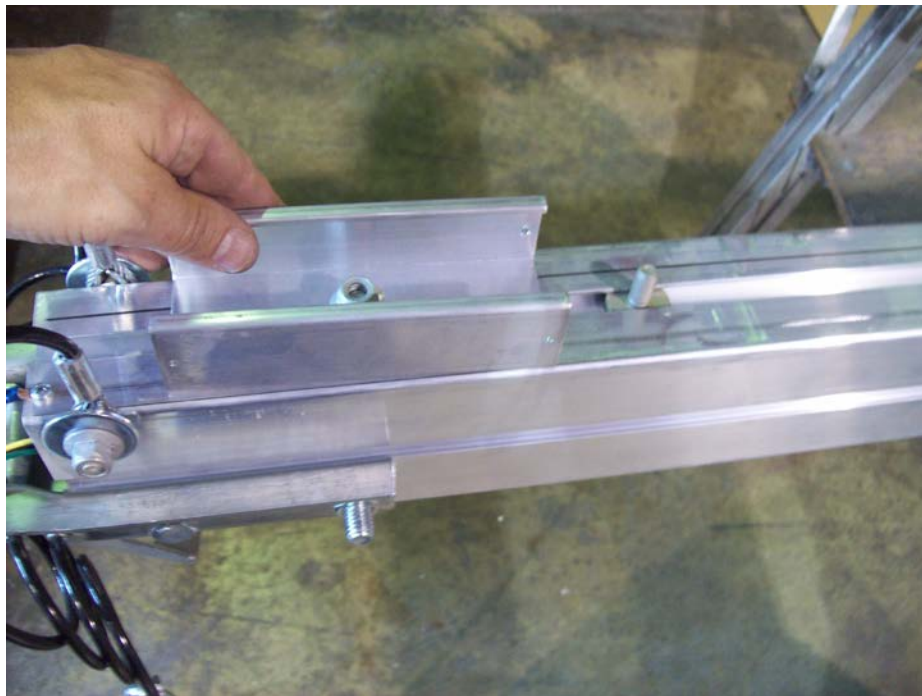

Take one T-bolt off the skid and slide it in the bottom of the tongue. Then install the bracket for the lights and position as shown.

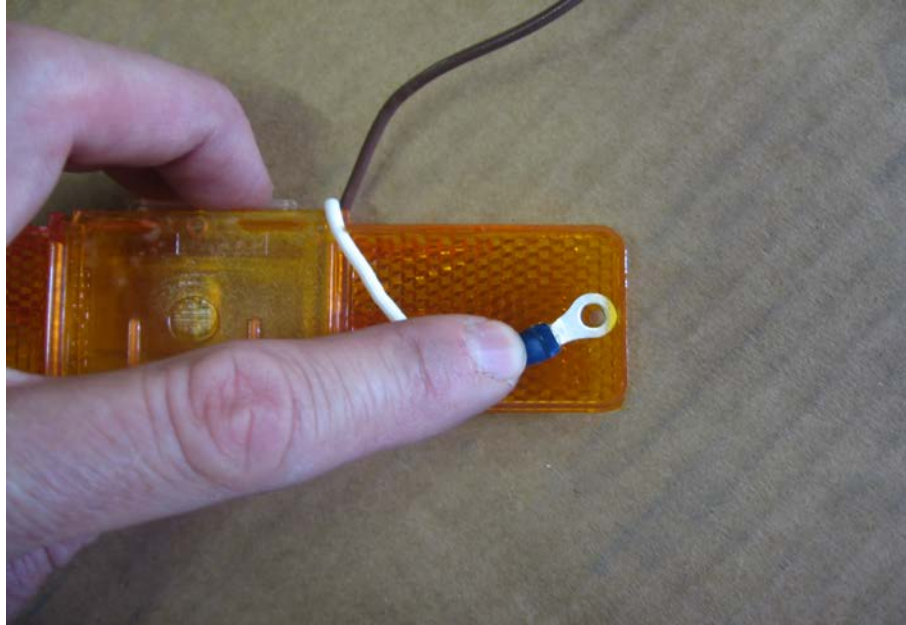

Align the ring terminals with the screw hole nearest the wire on the back of the running light. Make sure the wire is routed through the gap on the back of the light so it does not become pinched when the light is installed.

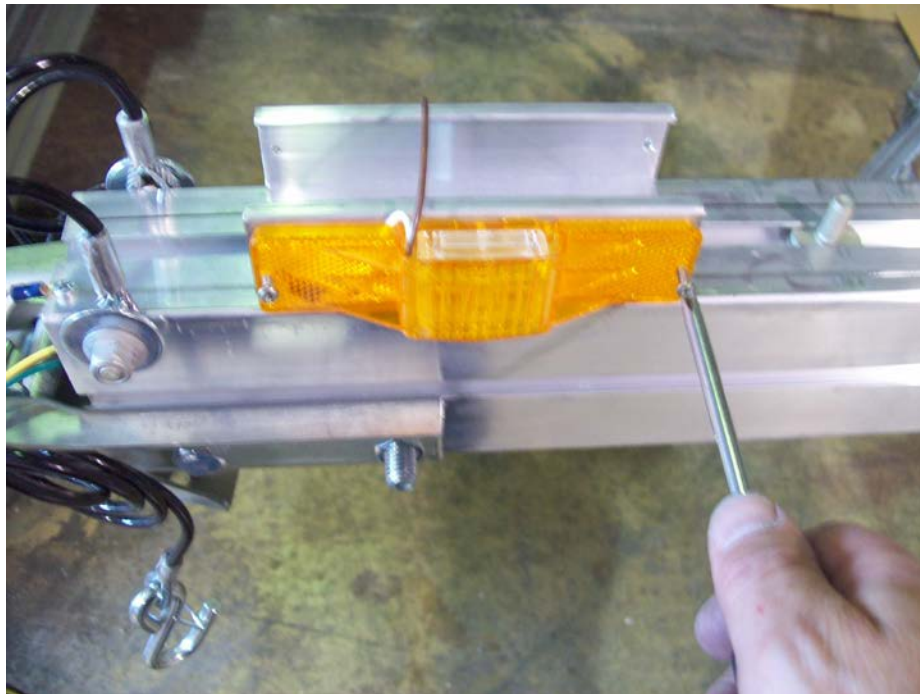

Install the running lights into the pre-drilled holes in the running light bracket using a Philips screwdriver. Be sure the screw is through the ring terminal on the back side of the lights. This will supply a ground to the lights. **DO NOT OVER TIGHTEN**

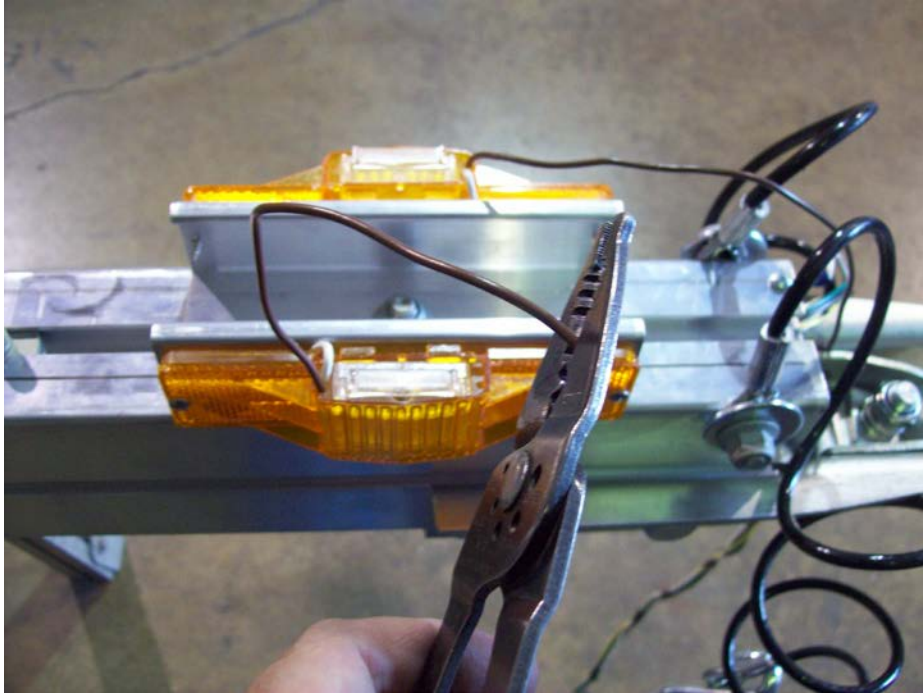

Cut 6" off of the brown wire on the left (driver's side) running light. Do not strip the wire.

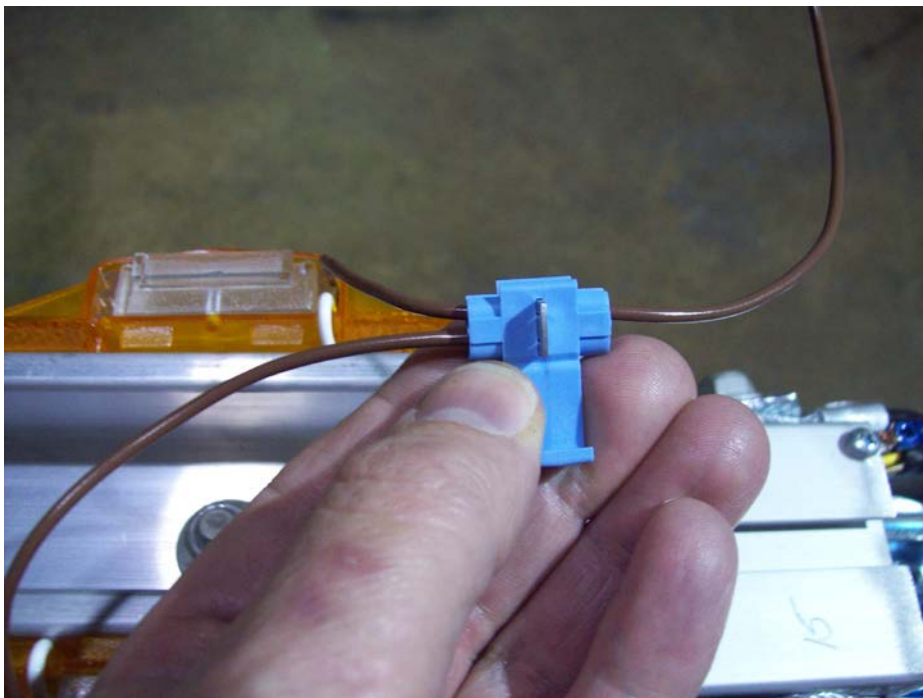

Insert brown wire that has been cut into the hole in the connector closest to the hinge. This hole does not pass all the way through. The wire should go in about $\frac{1}{2}$ ". Pass the other wire through the remaining open slot in the connector at a point close to the running lights.

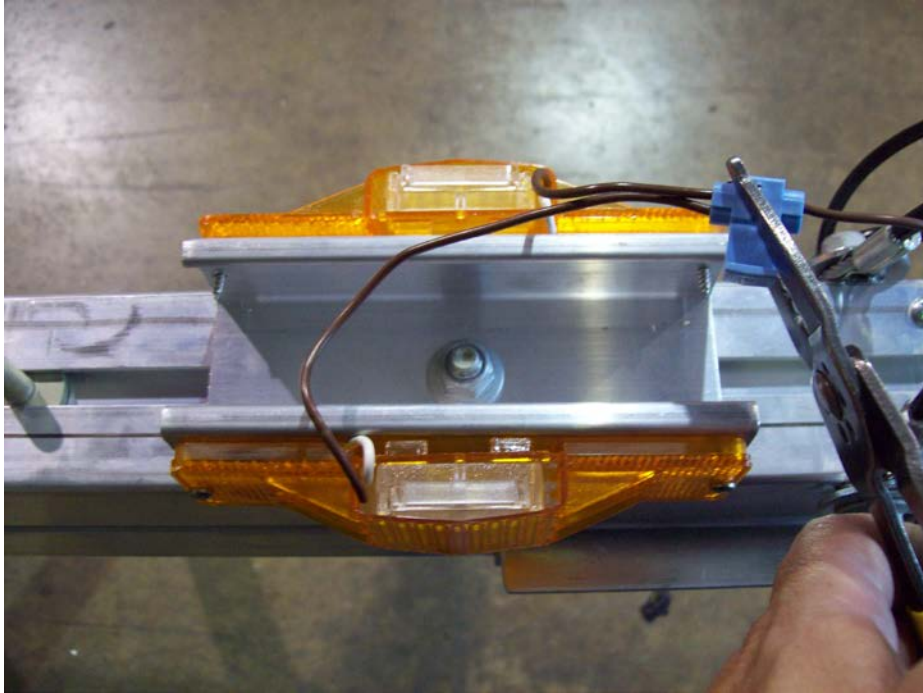

Use pliers to push the metal spade down until it is flush with the plastic. This is what makes the electrical connection between the two wires. Close the plastic cover of the connector over the spade until it snaps into position.



Cut the exposed strands of wire off of the end of the brown wire on the right (passenger side) running light.

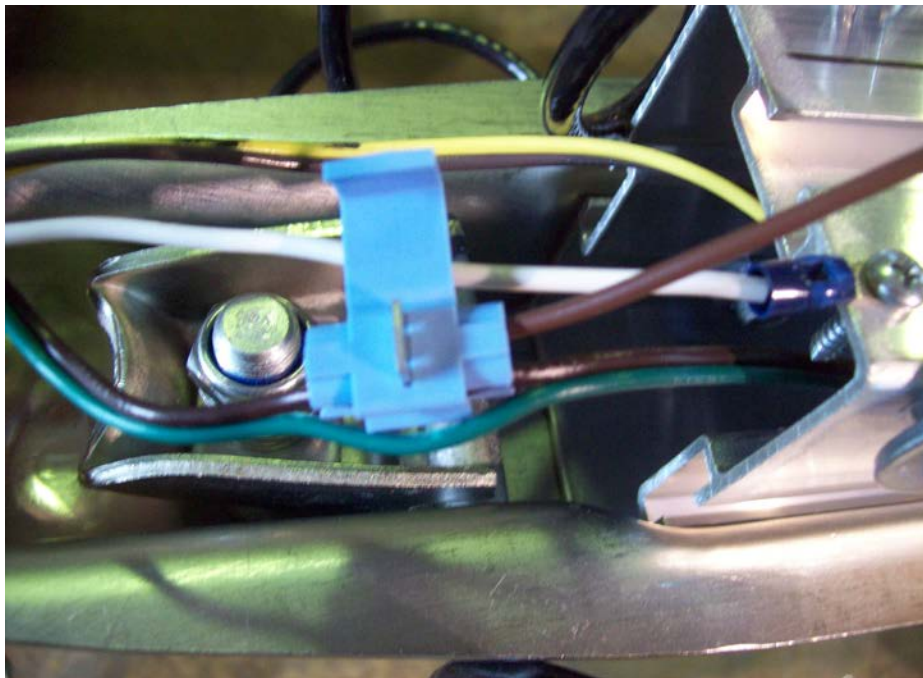

Measure 34" back from the front plug on the green/brown wire and separate the wires with a knife. Be sure not to cut through the casing. Pass the brown wire through the open slot in the second blue connector at this location. The green wire will rest just outside the connector. Insert the brown wire from the running lights into the closed side of the connector and close the spade and cover as previously described. This will make the connection from the main harness to both running lights.

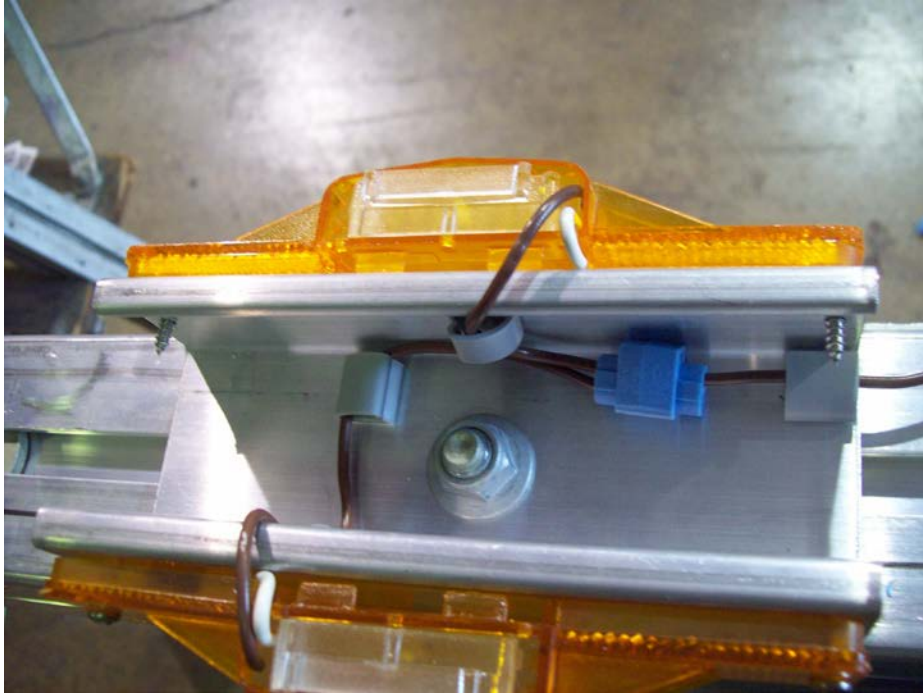

Locate the adhesive backed clamps. Install them as shown and run brown wire from the running lights through them.

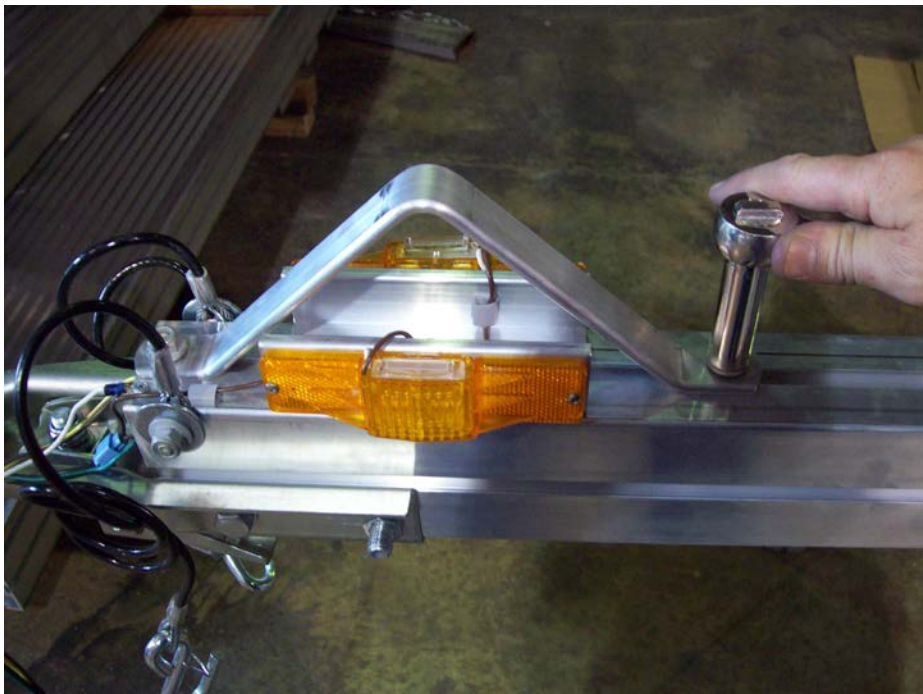

Install the skid on the front tongue section now. Tighten the nuts for the skid in the location as shown.



Tape wiring harness as shown.



Your wiring harness should look like this when finished.



Locate fenders, washers, T-bolts, and nuts.

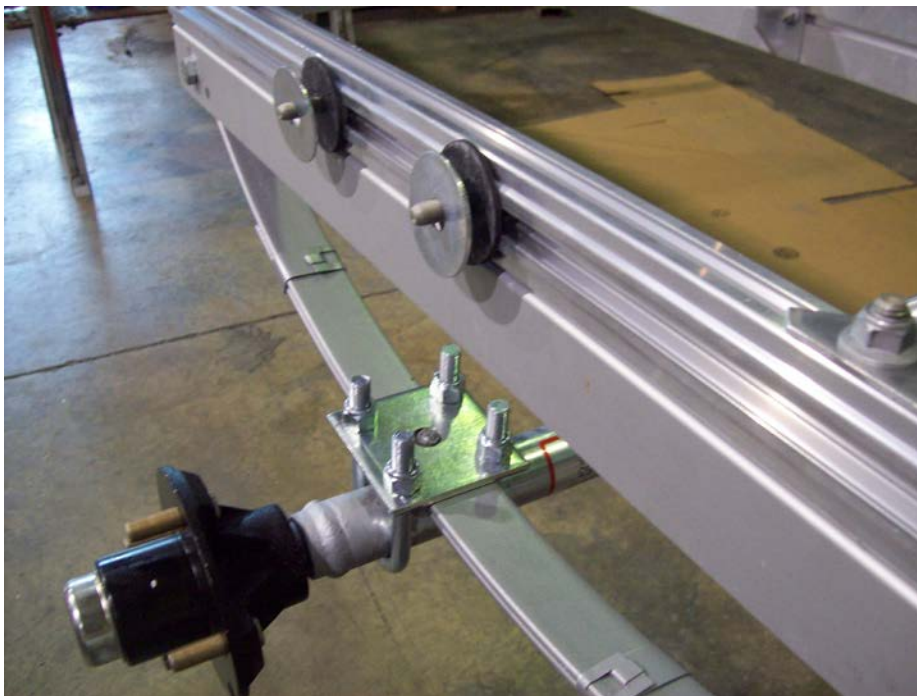

Locate (2) 1 1/8" T-bolts from the hardware bag and install them into the side rails. Slide them into position over the tire and install two rubber washers and two steel washers as shown.



Install the fender, two more steel washers, and nuts, center the fender over the axle and tighten the nuts. Repeat for the other side.

Wheel Installation



Locate 8 lug nuts, and wheels.



Install the wheels with the valve stems facing out. Install the lug nuts with the tapered side facing the wheel

Installation of vertical post and cross bars

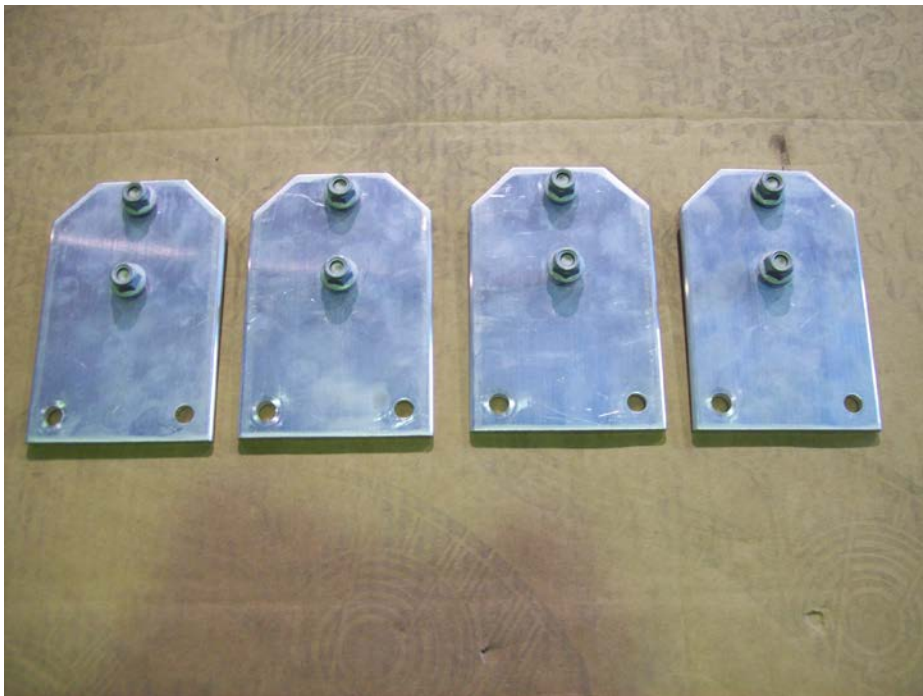

Locate four vertical support brackets.



Attach brackets to the T-bolts on the tongue section between the cross members as shown.



Insert vertical post into support brackets as shown. Leave nuts loose at this point to position the post.

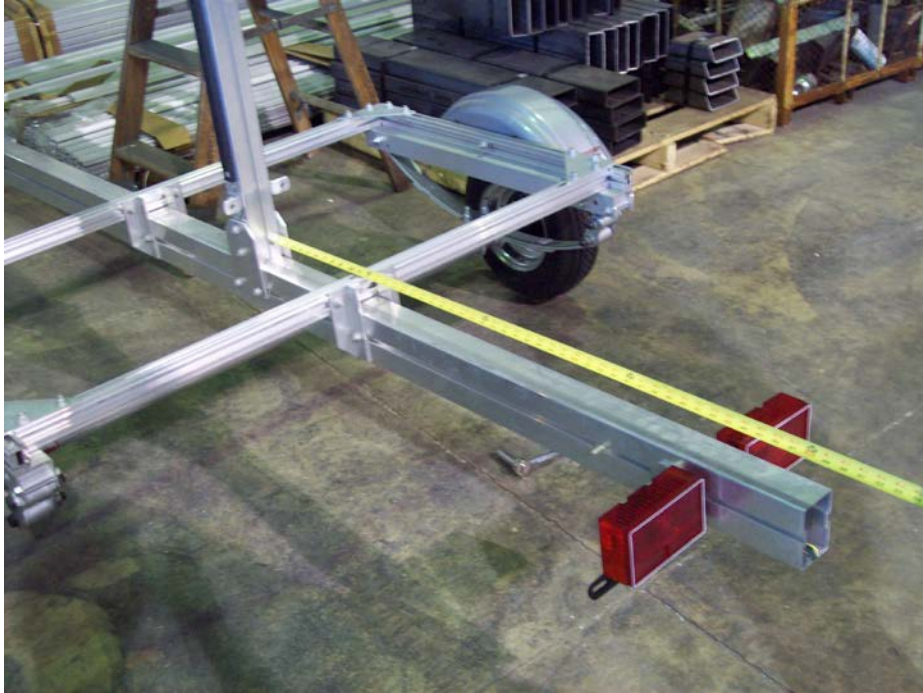

Position the vertical post 47 3/8" from the end of the tongue then square up the post and tighten nuts.



Install support brackets on the front tongue section. Be sure to use the two T-bolts closest to the splice plates as shown.



Insert post with crossbar brackets facing the front on the trailer. Leave nuts loose at this point to position the post.



Insert T-bolts from the top of the horizontal support into the angle brackets on the back side of the post. Slide lower brackets up on both sides, square up, then tighten nuts.



Your trailer should look like this at this point.



Remove the two nuts from the back side of all the crossbars for installation.



Insert the rear lower crossbar first that has angle brackets into the channel on the post. Position the underside of crossbar 5" from the top of the tongue.



Attach angle brackets from post to crossbars. Reinstall nuts but don't tighten them yet.



Loosen angles on both sides and attach to T-bolts in side rails. Make sure to square up everything then tighten nuts.



Insert the next crossbar. Position it 17" from the top of the bottom crossbar to the underside of the middle crossbar. Then repeat the process for attaching the remaining crossbars.

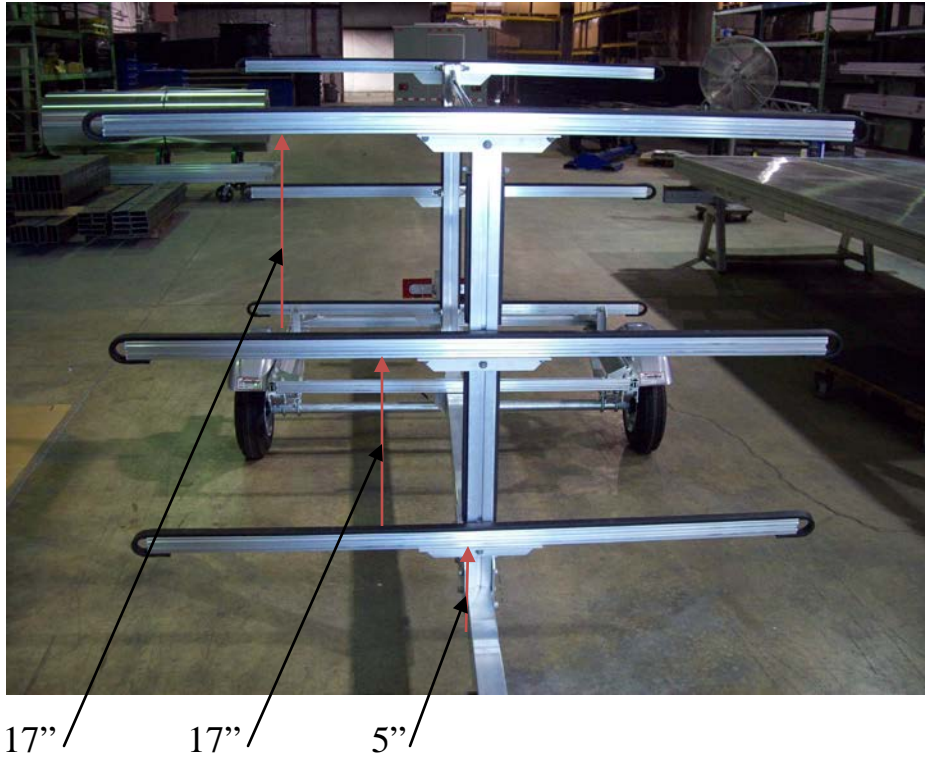

17" / 17" / 5"

This is the spacing on the cross bars front and aft.



Insert four web strap clips per crossbar.



Crossbars should look like this with web strap clips installed. Adjustments can be made later to accommodate boats or boards.



Attach angle supports to the vertical post and tongue section. Make sure to slide angle support post up against the underside of the cross member.



Adjust the support as shown then tighten all the nuts on the brackets.

Torque lug nuts



Tighten to 80 foot pounds in a crossing pattern. Re-tighten after 25 miles.

Finished trailer



KJM 7/14/11